

Protein assay technical handbook

Tools and reagents for improved quantitation of total or specific proteins

Contents



Introduction	3
Selection of the protein assay	4
Selection and preparation of protein standards	8
Sample preparation and considerations	12
<hr/>	
Copper-based total protein assays	20
BCA-based protein assays	21
Modified Lowry protein assay	29
<hr/>	
Dye-based total protein assays	32
Coomassie dye-based protein assays (Bradford assays)	33
Other dye-based assays	38
<hr/>	
Specialty assays	40
Other protein assays	41
Peptides	42
Antibodies	45
Proteases	47
Glycoproteins	48
Phosphoproteins	49
Peroxides	50
<hr/>	
Fluorescence-based protein detection	51
Fluorescence-based total protein assays	52
Amine detection	53
<hr/>	
Spectrophotometers and fluorometers	55
<hr/>	
Order information	58
<hr/>	

Find out more at [thermofisher.com/proteinassays](https://www.thermofisher.com/proteinassays)

Introduction

Protein quantitation is often necessary prior to further isolation and characterization of a protein sample. It is a required step before submitting protein samples for chromatographic, electrophoretic, and immunochemical separation or analyses.



Protein quantitation is most commonly performed using colorimetric assays. Typical methods for the colorimetric determination of protein concentration in solution include the Coomassie blue G-250 dye-binding assay [1], the biuret method [2], the Lowry method [3], the bicinchoninic acid (BCA) assay [4], and the colloidal gold protein assay [5]. The most common protein assay reagents involve either protein-dye binding chemistry (Coomassie/Bradford) or protein-copper chelation chemistry (biuret/BCA).

Every protein assay has limitations depending on the application and the specific protein sample analyzed. The most useful features to consider when choosing a protein assay are sensitivity (lower detection limit), compatibility with common substances in samples (e.g., detergents, reducing agents, chaotropic agents, inhibitors, salts, and buffers), standard curve linearity, and protein-to-protein variation. At Thermo Fisher Scientific, we understand these issues and offer numerous colorimetric and fluorescence assays for detection and quantitation of total protein. Our total protein and peptide quantitation assays are all well-characterized, robust assays that provide consistent, reliable results.

References

1. Bradford M (1976) A rapid and sensitive method for the quantitation of microgram quantities of protein utilizing the principle of protein-dye binding. *Anal Biochem* 72:248–254.
2. Gornall AG (1949) Determination of serum proteins by means of the biuret reaction. *J Biol Chem* 177:751–766.
3. Lowry OH et al. (1951) Protein measurement with the Folin phenol reagent. *J Biol Chem* 193:265–275.
4. Smith PK et al. (1985) Measurement of protein using bicinchoninic acid. *Anal Biochem* 150:76–85.
5. Stoscheck CM (1987) Protein assay sensitive at nanogram levels. *Anal Biochem* 160:301–305.

Selection of the protein assay

When it is necessary to determine the total protein concentration in a sample, one of the first factors to consider is the selection of a protein assay method. The choice among available protein assays is usually based on the compatibility of the protein assay method with the samples. Additionally, one must consider potential interfering substances included in samples that may affect certain assay methods. The objective is to select a method that requires the least manipulation or pretreatment of the samples. Each method has its advantages and disadvantages (Table 1). Because no one reagent can be considered to be the ideal or best for a protein assay

method, most researchers have more than one type of protein assay reagent available in their labs.

Some common substances that potentially interfere with protein assay methods are reducing agents and detergents. Table 1 also outlines the different protein assays with information on working ranges and compatibility of each assay with detergents and reducing agents.

In general, samples containing reducing agents or copper-chelating agents are preferentially analyzed with Coomassie dye-based assays. This is because Coomassie dye-based assays, such as the Thermo Scientific™ Pierce™ Coomassie (Bradford) and Pierce™ Coomassie Plus (Bradford) assays, are compatible with reducing agents and do not require copper-protein binding reactions. For those samples that contain detergents, copper-based protein assays such as the Thermo Scientific™ Pierce™ Rapid Gold BCA assay are the better choice as they are not inhibited by low to moderate amounts of detergent.

In addition to sample compatibility, protein assays are also commonly grouped by the range of protein concentrations they can detect. For samples in which protein concentration is expected to be low (<20 µg/mL), it may be necessary to use an assay's alternate microplate protocol or use a specialized assay, such as the Thermo Scientific™ Pierce™ Micro BCA protein assay, which is specifically designed for dilute samples. If the total protein concentration in the samples is high (>2,000 µg/mL), sample dilution can often be used to overcome any problems with known interfering substances.

Sometimes the sample contains substances that make it incompatible with any of the protein assay methods. The preferred method of dealing with these types of interfering substances is to simply remove them. We offer several methods for performing this function including dialysis, desalting, chemical blocking, and protein precipitation followed by resolubilization. This handbook focuses on the last two methods. Chemical blocking involves treating the sample with a material or compound that prevents the interfering substance from disrupting the protein assay chemistry.

Protein precipitation causes the protein to fall out of solution, at which time the interfering buffer can be replaced and the protein resolubilized. The chemical treatment method (e.g., the Thermo Scientific™ Pierce™ BCA Protein Assay Kit – Reducing Agent Compatible or the

Thermo Scientific™ Pierce™ 660 nm Protein Assay Reagent, which is both reducing agent–and detergent-compatible) is generally preferred. Unlike protein precipitation strategies, these chemical treatment methods do not involve resolubilization of potentially hydrophobic proteins.

Table 1. Quick technical summaries—Thermo Scientific™ Pierce™ protein and peptide assays.

Working range (sample volume)*	Advantages	Applications	Disadvantages	Interfering substances
Thermo Scientific™ Pierce™ Rapid Gold BCA Assay Kit				
Standard tube protocol: 20–2,000 µg/mL Microtube protocol: 20–2,000 µg/mL Standard microplate protocol: 20–2,000 µg/mL	<ul style="list-style-type: none"> Assay results in 5 min at room temperature Excellent linearity of color development within the detection range Two stable reagents used to make one working reagent Less than 10 min sample prep time Compatible with detergents Simple, easy to perform Less protein–protein variation than Coomassie dye methods Works with peptides (three amino acids or larger) 	<ul style="list-style-type: none"> Adapt for use with microplates Determine the amount of IgG-coated on plates Measure the amount of protein covalently bound to affinity supports Determine copper levels using a reagent formulated with Thermo Scientific™ Pierce™ BCA Reagent A [1] 	<ul style="list-style-type: none"> Working reagent stable for 1.5 hr Not a true endpoint assay Not compatible with thiols and reducing agents 	<ul style="list-style-type: none"> Reducing sugars and reducing agents Thiols Copper-chelating agents Ascorbic acid and uric acid Tyrosine, cysteine, and tryptophan
Thermo Scientific™ Pierce™ BCA Protein Assay Kit				
Standard protocol: 20–2,000 µg/mL (50 µL) Enhanced standard protocol: 5–250 µg/mL (50 µL) Microplate protocol: 20–2,000 µg/mL (25 µL)	<ul style="list-style-type: none"> Two stable reagents used to make one working reagent Working reagent stable for 1 week at room temperature Compatible with detergents Simple, easy to perform Less protein–protein variation than Coomassie dye methods Works with peptides (three amino acids or larger) Flexible incubation protocols allow customization of reagent sensitivity and working range 	<ul style="list-style-type: none"> Can adapt for use with microplates Determine the amount of IgG-coated on plates Measure the amount of protein covalently bound to affinity supports Determine copper levels using a reagent formulated with Thermo Scientific™ Pierce™ BCA Reagent A [1] 	<ul style="list-style-type: none"> Not compatible with thiols and reducing agents Requires heating for color development Not a true endpoint assay 	<ul style="list-style-type: none"> Reducing sugars and reducing agents Thiols Copper-chelating agents Ascorbic acid and uric acid Tyrosine, cysteine, and tryptophan 50 mM imidazole
Thermo Scientific™ Pierce™ BCA Protein Assay Kit – Reducing Agent Compatible				
Standard protocol: 125–2,000 µg/mL (25 µL) Microplate protocol: 125–2,000 µg/mL (9 µL)	<ul style="list-style-type: none"> Compatible with up to 5 mM dithiothreitol (DTT), 35 mM 2-mercaptoethanol, or 10 mM TCEP No protein precipitation necessary 9 µL sample volume (microplate protocol) Compatible with most detergents Significantly less (14–23%) protein–protein variation than Bradford-based methods 	<ul style="list-style-type: none"> Allows the use of the BCA assay in situations in which it is normally unable to be read Eliminates precipitation step, decreasing worries about difficult-to-solubilize proteins 	<ul style="list-style-type: none"> Requires heating for color development 	<ul style="list-style-type: none"> Compatible with all reducing agents and detergents found at concentrations routinely used in protein sample buffers

* Sample volume per 1 mL total assay volume for measurement in 1 cm cuvette (standard protocol). Sample volume per 200–300 µL total volume for measurement in 96-well microplate.

Table 1. Quick technical summaries—Pierce protein and peptide assays. (continued)

Working range (sample volume)*	Advantages	Applications	Disadvantages	Interfering substances
Thermo Scientific™ Pierce™ Micro BCA Protein Assay Kit				
<p>Standard protocol: 60°C for 60 min 0.5–20 µg/mL (0.5 mL)</p> <p>Microplate protocol: 37°C for 120 min 2–40 µg/mL (150 µL)</p>	<ul style="list-style-type: none"> • Three stable reagents used to make one working reagent • Working reagent stable for 24 hr at room temperature • Compatible with most detergents • Simple, easy to perform • Less protein–protein variation than BCA, Coomassie dye, or Lowry methods • Works with peptides (three amino acids or larger) • Linear color response to increasing protein concentration 	<ul style="list-style-type: none"> • Can be used for determining protein concentration in very dilute aqueous solutions • Can adapt for use with microplates [2] 	<ul style="list-style-type: none"> • More substances interfere at lower concentrations than with BCA assay because the sample volume-to-reagent volume ratio is 1:1 • 60°C water bath is needed 	<ul style="list-style-type: none"> • Reducing sugars and reducing agents • Thiols • Copper-chelating agents • Ascorbic acid and uric acid • Tyrosine, cysteine, and tryptophan • 50 mM imidazole
Thermo Scientific™ Pierce™ Modified Lowry Protein Assay Kit				
<p>Standard protocol: 1–1,500 µg/mL</p> <p>Microplate protocol: 10–1,500 µg/mL (40 µL)</p>	<ul style="list-style-type: none"> • Two-reagent system with a shelf life of at least 1 year • Two-step incubation requires precise sequential timing of samples • Color response read at 750 nm • Works with peptides (three amino acids or larger) • Protein–protein variation similar to that seen with BCA method • Many authors have reported ways to deal with substances that interfere 	<ul style="list-style-type: none"> • Lowry method is one of the most cited protein assays in the literature • Can be adapted for use with microplates 	<ul style="list-style-type: none"> • Timed addition of Folin’s reagent adds complexity • Longer total assay time • Practical limit of about 20 samples per run 	<ul style="list-style-type: none"> • Detergents (cause precipitation) • Thiols, disulfides • Copper-chelating reagents • Carbohydrates including hexosamines and their <i>N</i>-acetyl derivatives • Glycerol, Tris, tricine, K⁺ ions
Thermo Scientific™ Pierce™ Detergent Compatible Bradford Assay Kit				
<p>Standard tube protocol: 100–1,500 µg/mL (50 µL)</p> <p>Microtube protocol: 2–25 µg/mL (1,000 µL)</p> <p>Standard plate protocol: 100–1,500 µg/mL (10 µL)</p> <p>Microplate protocol: 2–25 µg/mL (150 µL)</p>	<ul style="list-style-type: none"> • Simple 1-step protocol • Single reagent system with no preparation of working solution required • Broad detection range from 2 to 1,500 µg/mL • Minimal sample required (10 µL) • Compatible with both detergents and reducing reagents • Fast results—total assay time under ~30 min 	<ul style="list-style-type: none"> • Rapid analysis of samples that are incompatible with traditional Bradford assay due to the presence of detergents 	<ul style="list-style-type: none"> • High protein–protein variation • Assay linearity is lower compared to that of copper-based protein assays 	<ul style="list-style-type: none"> • Compatible with most detergents and reducing agents at standard concentrations
Thermo Scientific™ Pierce™ Coomassie Plus (Bradford) Assay Kit				
<p>Standard protocol: Sample-to-reagent ratio: 1:30 100–1,500 µg/mL (35 µL)</p> <p>Microplate protocol: Sample-to-reagent ratio: 1:1 1–25 µg/mL (150 µL)</p>	<ul style="list-style-type: none"> • Simple, fast protocols • Total preparation and assay time <30 min • One-reagent system; stable for 12 months • Ready-to-use formulation—no dilution or filtration needed • Nearly immediate color development at room temperature • Linear color response in standard assay (more accurate results) • Color response sensitive to changes in pH • Temperature dependence of color response • Compatible with buffer salts, metal ions, reducing agents, and chelating agents • Low-odor formulation 	<ul style="list-style-type: none"> • Standard assay [3] • Micro assay [4–6] • Microplate format assay [7] • Assay of protein solutions containing reducing agents [8] • Quantitation of immobilized protein [9] • Protein in permeabilized cells [10] • NaCNBH₃ determination [11] 	<ul style="list-style-type: none"> • Less linear color response in the micro assay • Effect of interfering substances more pronounced in the micro assay • Protein–dye complex has tendency to adhere to glass (easily removed with MeOH) [12] • Protein must be >3,000 Da 	<ul style="list-style-type: none"> • Detergents [13]

* Sample volume per 1 mL total assay volume for measurement in 1 cm cuvette (standard protocol). Sample volume per 200–300 µL total volume for measurement in 96-well microplate.

Table 1. Quick technical summaries—Pierce protein and peptide assays. (continued)

Working range (sample volume)*	Advantages	Applications	Disadvantages	Interfering substances
Thermo Scientific™ Pierce™ Coomassie (Bradford) Protein Assay Kit				
<p>Standard protocol: Sample-to-reagent ratio: 1:50 100–1,500 µg/mL (20 µL)</p> <p>Microplate protocol: Sample-to-reagent ratio: 1:1 1–25 µg/mL (150 µL)</p>	<ul style="list-style-type: none"> • Simple-to-perform protocols • One-reagent system, stable for 12 months • Ready-to-use formulation • No dilution or filtration needed • Fast, nearly immediate color development at room temperature • Total preparation and assay time <30 min • Typical protein–protein variation expected for a Coomassie dye–based reagent • Color response sensitive to pH • Temperature-dependent color response • Compatible with buffer salts, metal ions, reducing agents, and chelating agents 	<ul style="list-style-type: none"> • Standard assay [3] • Micro assay [4–6] • Microplate format assay [14] • Assay of protein solutions containing reducing agents • Cell line lysates [15] • Protein recovery studies 	<ul style="list-style-type: none"> • Nonlinear color response • More protein standard concentrations required to cover working range • Micro assay has potential for interference • Protein must be >3,000 Da 	<ul style="list-style-type: none"> • Detergents [13]
Thermo Scientific™ Pierce™ 660 nm Protein Assay Reagent				
<p>Standard protocol: 25–2,000 µg/mL (65 µL)</p> <p>Microplate protocol: 50–2,000 µg/mL (10 µL)</p>	<ul style="list-style-type: none"> • Compatible with reducing agents, chelating agents, and detergents • Faster and easier to perform than BCA or Coomassie (Bradford) assays • Excellent linearity of color development within the detection range • Less protein–protein variation than the Coomassie (Bradford) assay • Reaches a stable endpoint • Compatible with Laemmli sample buffer containing bromophenol blue when using Thermo Scientific™ Ionic Detergent Compatibility Reagent 	<ul style="list-style-type: none"> • Measures total protein concentration in samples containing both reducing agents and detergents • Use for quick, yet accurate estimation of protein 	<ul style="list-style-type: none"> • Use reagent with Ionic Detergent Compatibility Reagent with samples containing ionic detergents like SDS • Displays greater protein–protein variation than the BCA assay 	<ul style="list-style-type: none"> • High levels of ionic detergents require the addition of the Ionic Detergent Compatibility Reagent
Thermo Scientific™ Pierce™ Quantitative Colorimetric Peptide Assay				
<p>Standard microplate protocol: 25–1,000 µg/mL</p>	<ul style="list-style-type: none"> • Assay results in 30 min at room temperature • Excellent linear range of 15–1,000 µg/mL and sensitivity down to 15 µg/mL • Two stable reagents used to make one working reagent • Less than 10 min sample prep time • Compatible with commonly used mass spec reagents • Simple, easy to perform 	<ul style="list-style-type: none"> • Accurate quantitation of tandem mass tag (TMT) or biotin-labeled peptides 	<ul style="list-style-type: none"> • Not recommended for individual peptide quantitation • Not a true endpoint assay • Not compatible with reducing and chelating reagents 	<ul style="list-style-type: none"> • Reducing agents such as TCEP and DTT • Chelating agents such as EDTA
Thermo Scientific™ Pierce™ Quantitative Fluorometric Peptide Assay				
<p>Standard microplate protocol: 25–1,000 µg/mL</p>	<ul style="list-style-type: none"> • Assay results in 30 min at room temperature • Excellent linear range of 15–1,000 µg/mL and sensitivity down to 15 µg/mL • Two stable reagents used to make one working reagent • Less than 10 min sample prep time • Compatible with commonly used mass spec reagents • Simple, easy to perform 	<ul style="list-style-type: none"> • Accurate quantitation of TMT or biotin-labeled peptides 	<ul style="list-style-type: none"> • Not recommended for individual peptide quantitation • Not a true endpoint assay • Not compatible with reducing and chelating reagents 	<ul style="list-style-type: none"> • Reducing agents such as TCEP and DTT • Chelating agents such as EDTA

* Sample volume per 1 mL total assay volume for measurement in 1 cm cuvette (standard protocol). Sample volume per 200–300 µL total volume for measurement in 96-well microplate.

References

1. Brenner AJ, Harris ED (1995) A quantitative test for copper using bicinchoninic acid. *Anal Biochem* 226:80–84.
2. Redinbaugh MG, Turley RB (1986) Adaptation of the bicinchoninic acid protein assay for use with microtiter plates and sucrose gradient fractions. *Anal Biochem* 153:267–271.
3. Bradford MM (1976) A rapid and sensitive method for the quantitation of microgram quantities of protein utilizing the principle of protein-dye binding. *Anal Biochem* 72:248–254.
4. Pande SV, Murthy SR (1994) A modified micro-Bradford procedure for elimination of interference from sodium dodecyl sulfate, other detergents and lipids. *Anal Biochem* 220:424–426.
5. Brogdon WG, Dickinson CM (1983) A microassay system for measuring esterase activity and protein concentration in small samples and in high pressure liquid chromatography eluate fractions. *Anal Biochem* 131:499–503.
6. Simpson IA, Sonne O (1982) A simple, rapid and sensitive method for measuring protein concentration in subcellular membrane fractions prepared by sucrose density ultracentrifugation. *Anal Biochem* 119:424–427.
7. Redinbaugh MG, Campbell WH (1985) Adaptation of the dye-binding protein assay to microtiter plates. *Anal Biochem* 147:144–147.
8. Ribin RW, Warren RW (1977) Quantitation of microgram amounts of protein in SDS-mercaptoethanol-Tris electrophoresis sample buffer. *Anal Biochem* 83:773–777.
9. Bonde M, Pontoppidan H, Pepper DS (1992) Direct dye binding—a quantitative assay for solid-phase immobilized protein. *Anal Biochem* 200:195–198.
10. Alves Cordeiro CA, Freire AP (1994) Protein determination in permeabilized yeast cells using the Coomassie brilliant blue dye binding assay. *Anal Biochem* 223:321–323.
11. Sorensen K (1994) Coomassie protein assay reagent used for quantitative determination of sodium cyanoborohydride (NaCNBH₃). *Anal Biochem* 218:231–233.
12. Gadd KG (1981) Protein estimation in spinal fluid using Coomassie blue reagent. *Med Lab Sci* 38:61–63.
13. Friedenauer D, Berlet HH (1989) Sensitivity and variability of the Bradford protein assay in the presence of detergents. *Anal Biochem* 178:263–268.
14. Splittgerber AG, Sohl J (1989) Nonlinearity in protein assays by the Coomassie blue dye-binding method. *Anal Biochem* 179(1):198–201.
15. Tsukada T et al. (1987) Identification of a region in the human vasoactive intestinal polypeptide gene responsible for regulation by cyclic AMP. *J Biol Chem* 262:8743–8747.

Related references

- Sorensen K, Brodbec U (1986) A sensitive protein assay using microtiter plates. *J Immunol Meth* 95:291–293.
- Stich TM (1990) Determination of protein covalently bound to agarose supports using bicinchoninic acid. *Anal Biochem* 191:343–346.
- Akins RE, Tuan RS (1992) Measurement of protein in 20 seconds using a microwave BCA assay. *Biotechniques* 12:496–499.
- Brown RE et al. (1989) Protein measurement using bicinchoninic acid: elimination of interfering substances. *Anal Biochem* 180:136–139.
- Peterson GL (1983) In: *Methods Enzymol* (Hirs CHW, Timasheff SN, eds.), Vol. 91, pp. 95–119. Academic Press.

Selection of a protein standard

Selection of a protein standard is potentially the greatest source of error in any protein assay. The best choice for a standard is a highly purified version of the predominant protein found in the samples. However, this is not always possible or necessary.

When only a rough estimate of the total protein concentration is needed, such as the early stages of protein purification, one may forgo expensive or difficult-to-obtain highly purified protein standards. The alternatives for such standards are proteins that produce very similar color response curves to the protein of interest for the chosen protein assay method.

For general protein assay work, bovine serum albumin (BSA) works well for a protein standard because it is widely available in high purity and is relatively inexpensive. Although bovine gamma globulin (BGG) is a mixture containing several immunoglobulins, it still is a good choice for a standard to determine antibody concentration because BGG produces a colorimetric response curve very similar to that of immunoglobulin G (IgG).

For the greatest accuracy in estimating total protein concentration in unknown samples, it is essential to include a standard curve each time the assay is performed. This is particularly true for the protein assay methods that produce nonlinear standard curves. Determination of the number of standards and replicates used to define the standard curve depends upon the degree of nonlinearity in the standard curve and the degree of accuracy required. In general, fewer points are needed to construct a standard curve if the colorimetric response is linear. Typically, standard curves are constructed using at least two replicates for each point on the curve.

Preparation of standards

The following tables (Tables 2–5) provide information to prepare a set of protein standards for various Pierce protein assays. This information is only a guide that covers BSA standards; consult the information supplied with a given standard for more accurate guidelines.

To proceed, dilute the contents of a 1 mL BSA standard (2 mg/mL) into several clean vials, preferably using the same diluent as the test sample(s). Thermo Scientific™ Pierce™ BSA standards are sufficient to prepare a set of diluted standards for the working ranges suggested, with sufficient volume for three replications of each diluted standard.

Table 2. Preparation of BSA standards for Pierce Rapid Gold BCA assay, Pierce BCA assay, Pierce BCA reducing agent compatible assay, and Pierce 660 nm assay.

Dilution scheme for standard test tube and microplate protocols (For product working range, see Table 1.)			
Vial	Volume of diluent	Volume and source of BSA	Final BSA concentration
A	0	300 µL of stock	2,000 µg/mL
B	125 µL	375 µL of stock	1,500 µg/mL
C	325 µL	325 µL of stock	1,000 µg/mL
D	175 µL	175 µL of vial B dilution	750 µg/mL
E	325 µL	325 µL of vial C dilution	500 µg/mL
F	325 µL	325 µL of vial E dilution	250 µg/mL
G	325 µL	325 µL of vial F dilution	125 µg/mL
H	400 µL	100 µL of vial G dilution	25 µg/mL
I	400 µL	0	0 µg/mL = blank

Dilution scheme for enhanced test tube protocol (For product working range, see Table 1.)			
Vial	Volume of diluent	Volume and source of BSA	Final BSA concentration
A	700 µL	100 µL of stock	250 µg/mL
B	400 µL	400 µL of vial A dilution	125 µg/mL
C	450 µL	300 µL of vial B dilution	50 µg/mL
D	400 µL	400 µL of vial C dilution	25 µg/mL
E	400 µL	100 µL of vial D dilution	5 µg/mL
F	400 µL	0	0 µg/mL = blank

Table 3. Preparation of BSA standards for Pierce Micro BCA assay.

Dilution scheme for standard and microplate protocols (For product working range, see Table 1.)			
Vial	Volume of diluent	Volume and source of BSA	Final BSA concentration
A	0.9 mL	0.1 mL of stock	200 µg/mL
B	0.8 mL	0.2 mL of vial A dilution	40 µg/mL
C	0.5 mL	0.5 mL of vial B dilution	20 µg/mL
D	0.5 mL	0.5 mL of vial C dilution	10 µg/mL
E	0.5 mL	0.5 mL of vial D dilution	5 µg/mL
F	0.5 mL	0.5 mL of vial E dilution	2.5 µg/mL
G	0.6 mL	0.4 mL of vial F dilution	1 µg/mL
H	0.5 mL	0.5 µL of vial G dilution	0.5 µg/mL
I	1.0 mL	0	0 µg/mL = blank

Table 4. Preparation of BSA standards for Pierce Coomassie Plus (Bradford) assay, Pierce Coomassie (Bradford) assay, and Pierce Detergent Compatible Bradford assay.

Dilution scheme for standard test tube and microplate protocols (For product working range, see Table 1.)			
Vial	Volume of diluent	Volume and source of BSA	Final BSA concentration
A	0	300 µL of stock	2,000 µg/mL
B	125 µL	375 µL of stock	1,500 µg/mL
C	325 µL	325 µL of stock	1,000 µg/mL
D	175 µL	175 µL of vial B dilution	750 µg/mL
E	325 µL	325 µL of vial C dilution	500 µg/mL
F	325 µL	325 µL of vial E dilution	250 µg/mL
G	325 µL	325 µL of vial F dilution	125 µg/mL
H	400 µL	100 µL of vial G dilution	25 µg/mL
I	400 µL	0	0 µg/mL = blank

Dilution scheme for micro test tube and microplate protocols (For product working range, see Table 1.)			
Vial	Volume of diluent	Volume and source of BSA	Final BSA concentration
A	237 µL	3 µL of stock	25 µg/mL
B	495 µL	5 µL of stock	20 µg/mL
C	397 µL	3 µL of stock	15 µg/mL
D	250 µL	250 µL of vial B dilution	10 µg/mL
E	200 µL	200 µL of vial D dilution	5 µg/mL
F	150 µL	150 µL of vial E dilution	2.5 µg/mL
G	500 µL	0	0 µg/mL = blank

Table 5. Preparation of BSA standards for Pierce Modified Lowry assay.

Dilution scheme for test tube and microplate protocols (For product working range, see Table 1.)			
Vial	Volume of diluent	Volume and source of BSA	Final BSA concentration
A	250 µL	750 µL of stock	1,500 µg/mL
B	500 µL	500 µL of vial A dilution	1,000 µg/mL
C	0.5 mL	500 µL of vial A dilution	750 µg/mL
D	500 µL	500 µL of vial B dilution	500 µg/mL
E	500 µL	500 µL of vial D dilution	250 µg/mL
F	500 µL	500 µL of vial E dilution	125 µg/mL
G	800 µL	200 µL of vial F dilution	25 µg/mL
H	1,000 µL	0	0 µg/mL = blank

Standards for total protein assay

Pierce Bovine Serum Albumin (BSA) Standard Ampules, 2 mg/mL



Thermo Scientific™ Pierce™ BSA Standard Ampules provide high-quality reference samples for generating accurate standard curves and calibration controls for BCA, Bradford, and other total protein assays.

Highlights:

- **Convenient**—1 mL ampules
- **Universal**—widely used for protein quantitation in colorimetric protein assays
- **Accurate and consistent**—precisely formulated at 2.00 ± 0.03 mg/mL in ultrapure 0.9% saline solution with 0.05% sodium azide, and compared to a National Institute of Standards and Technology (NIST) reference

Pierce BSA Protein Assay Standard Pre-Diluted Set



Thermo Scientific™ Pierce™ BSA Protein Assay Pre-Diluted Sets provide ready-to-use BSA dilution series for generating accurate standard curves and calibration controls for BCA, Coomassie (Bradford), and other total protein assays. The set will generate seven data points with a range of 125–2,000 $\mu\text{g/mL}$. Each kit contains sufficient materials to prepare 15–35 standard tube protocol curves or 175–350 standard microplate protocol curves running duplicate data points.

Highlights:

- **Convenient**—complete set containing seven ready-to-use dilutions
- **Universal**—widely used for protein quantitation in colorimetric protein assays
- **Pure and stable**—supplied in ultrapure 0.9% saline solution with 0.05% sodium azide
- **Standard curve range**—125–2,000 $\mu\text{g/mL}$

Pierce Bovine Gamma Globulin (BGG) Standard Ampules, 2 mg/mL



Thermo Scientific™ Pierce™ BGG Standard Ampules provide high-quality reference samples for generating accurate standard curves and calibration controls in total protein assays, and are especially recommended for Coomassie (Bradford) protein assays. BGG is an accepted reference protein for total protein quantitation of purified antibodies or immunoglobulin-rich samples.

Highlights:

- **Convenient**—1 mL ampules
- **Antibody standard**—one of the best reference standards for immunoglobulin quantitation in colorimetric protein assays
- **Bradford standard**—one of the best general protein standards for Coomassie-based (Bradford) protein assays
- **Accurate and consistent**—precisely formulated at 2.00 ± 0.03 mg/mL in ultrapure 0.9% saline solution with 0.05% sodium azide, helps to ensure excellent lot-to-lot consistency

Pierce BGG Protein Assay Standard Pre-Diluted Set



Thermo Scientific™ Pierce™ BGG Protein Assay Standard Pre-Diluted Sets provide a ready-to-use BGG dilution series for generating accurate standard curves and calibration controls for total protein assays.

Highlights:

- **Convenient**—complete set containing seven ready-to-use dilutions
- **Antibody standard**—one of the best reference standards for immunoglobulin quantitation in colorimetric protein assays
- **Bradford standard**—one of the best general protein standards for Coomassie-based (Bradford) protein assays
- **Accurate and consistent**—precisely formulated at 2.00 ± 0.03 mg/mL in ultrapure 0.9% saline solution with 0.05% sodium azide, helps to ensure excellent lot-to-lot consistency

Sample preparation

Before a sample is analyzed for total protein content, it must be solubilized, usually in a buffered aqueous solution. The sample is kept cold during the entire process, with additional precautions taken to inhibit microbial growth or to avoid casual contamination of the sample by foreign debris such as hair, skin, or body oils.

When working with tissues, cells, or solids, the first step of the solubilization process is usually disruption of the sample's cellular structure by grinding and/or sonication, or by the use of specially designed reagents (e.g., Thermo Scientific™ Pierce™ cell lysis reagents) containing surfactants to lyse the cells. This is done in an aqueous buffer containing one or more surfactants to aid the solubilization of the membrane-bound proteins, biocides (antimicrobial agents), and protease inhibitors. After filtration or centrifugation to remove the cellular debris, additional steps such as sterile filtration, removal of lipids, or further purification of the protein of interest from the other sample components may be necessary.

Non-protein substances in the sample that are expected to interfere in the chosen protein assay method may be removed by dialysis with Thermo Scientific™ Slide-A-Lyzer™ Dialysis Cassettes or Thermo Scientific™ SnakeSkin™ Dialysis Tubing, gel filtration using any of the Thermo Scientific™ desalting column formats, or precipitation as in the Thermo Scientific™ Compat-Able™ protein assays or Thermo Scientific™ SDS-Out™ SDS Precipitation Kit.

Protein–protein variation

Each protein in a sample is different and therefore exhibits a unique colorimetric response when processed using a particular protein assay method. These differences in color response relate to differences in amino acid sequence, isoelectric point (pI), secondary structure, and the presence of certain side chains or prosthetic groups.

Protein–protein variation may be a consideration in selecting a protein assay method, especially if the relative color response ratio of the protein in the samples is unknown. Table 6 (page 13) shows the relative degree of protein–protein variation that can be expected with different Pierce protein assay reagents. For each of the nine methods presented, a group of 14 proteins was assayed using the standard protocol in a single run. The net (blank-corrected) average absorbance for each protein was calculated. The net absorbance for each protein is expressed as a ratio to the net absorbance for BSA. If a protein has a ratio of 0.80, it means that the protein produces 80% of the color obtained for an equivalent mass of BSA.

The results show that protein assay methods using the same basic chemistry show similar protein–protein variation. These data also highlight how important it is to choose an appropriate standard protein. Using a standard protein that is extremely dissimilar to the protein of interest could introduce a large source of error when calculating protein concentration.

Table 6. Protein–protein variation for various protein assay methods. This table provides useful estimates of the expected protein–protein variation in color response with each protein assay method. However, keep in mind that these comparisons were made using a single protein concentration, which would not account for changes seen in the color response ratio with changes in protein concentration. For the Pierce BCA protein assay, Pierce Modified Lowry protein assay, Pierce Coomassie (Bradford) assay, and the Pierce Coomassie Plus (Bradford) assay, all proteins were tested using the standard tube protocol at a concentration of 1,000 µg/mL. For the Pierce Micro BCA Protein assay, the proteins were tested using the standard tube protocol at a protein concentration of 10 µg/mL. For the Pierce Detergent Compatible Bradford assay and the Pierce Rapid Gold BCA assay, the proteins were tested using the standard microplate protocol without detergent at a concentration of 1,000 µg/mL. Samples not tested are designated with an “x”.

Protein tested	Pierce Rapid Gold BCA ratio	Pierce BCA ratio	Pierce Micro BCA ratio	Pierce Modified Lowry ratio	Pierce Detergent Compatible Bradford ratio	Pierce Coomassie Plus ratio	Pierce Coomassie (Bradford) ratio	Pierce 660 nm assay ratio*
Albumin, bovine serum	1.00	1.00	1.00	1.00	1.00	1.00	1.00	1.00
Aldolase, rabbit muscle	1.22	0.85	0.94	0.94	1.03	0.74	0.76	0.83
α-chymotrypsinogen	1.46	1.14	0.99	1.17	0.43	0.52	0.48	x
Cytochrome c, horse heart	1.27	0.83	1.11	0.94	0.72	1.03	1.07	1.22
Gamma globulin, bovine	1.58	1.11	0.95	1.14	0.59	0.58	0.56	0.51
IgG, bovine	1.64	1.21	1.12	1.29	0.70	0.63	0.58	x
IgG, human	1.43	1.09	1.03	1.13	0.74	0.66	0.63	0.57
IgG, mouse	1.40	1.18	1.23	1.20	0.66	0.62	0.59	0.48
IgG, rabbit	1.52	1.12	1.12	1.19	0.31	0.43	0.37	0.38
IgG, sheep	1.24	1.17	1.14	1.28	0.59	0.57	0.53	x
Insulin, bov. pancreas	1.34	1.08	1.22	1.12	0.40	0.67	0.60	0.81
Myoglobin, horse heart	0.96	0.74	0.92	0.90	0.94	1.15	1.19	1.18
Ovalbumin	1.18	0.93	1.08	1.02	0.29	0.68	0.32	0.54
Transferrin, human	1.16	0.89	0.98	0.92	1.06	0.90	0.84	0.80
Average ratio	1.31	1.02	1.05	1.09	0.67	0.73	0.68	0.74
Standard deviation	0.20	0.15	0.12	0.13	0.26	0.21	0.26	0.27
Coefficient of variation (CV)	15.6%	14.7%	11.4%	11.9%	38.5%	28.8%	38.2%	37.0%

*Protein-to-protein variation was measured with 14 proteins for the Pierce 660 nm assay; 11 of these proteins are included in this table.

Accommodating for and removing interfering substances

Virtually every protein detection method known exhibits sensitivity to the presence of particular reagents in the protein sample. Proteins are typically found in solutions that contain detergents, buffer salts, denaturants, reducing agents, chaotropic agents, and/or antimicrobial preservatives. These additives may affect the results of an assay. When a component of a protein solution artificially increases or decreases the signal of any assay, the component is considered to be an interfering substance.

Interfering substances can affect the protein assay by:

- Suppressing the response of an assay
- Enhancing the response of an assay
- Elevating the background reading

A small amount of interference from many common substances can be compensated for in the blank designed for a specific assay. To compensate for the interference, the protein samples for the standard curve must be diluted in the same buffer as the protein being assayed. Often, interfering substances can overwhelm the assay, making it difficult or impossible to perform. The two most popular assay methods, Lowry- and Bradford-based assays, are both strongly affected by various components found in standard sample buffers. Lowry-based methods are incompatible with reducing and chelating agents (e.g., DTT, 2-mercaptoethanol, cysteine, EDTA, and some sugars), while Bradford-based methods are incompatible with most detergents. Unfortunately, many common sample buffers contain both reducing agents and detergents (e.g., Laemmli buffer).

Interfering substances can be removed by a variety of means, of which gel filtration and dialysis are the most common. However, both of these methods are time-consuming and can result in diluted protein samples. The Thermo Scientific™ Compat-Able™ Protein Assay Preparation Reagent Kit (page 41) was developed to solve this problem. The Compat-Able reagents render potentially interfering substances virtually invisible to either a Lowry- (copper reduction-) or Bradford-based assay (Table 7). These unique reagents dispose of any possible interfering substances in your sample by selectively precipitating the protein, allowing the non-protein sample components to be removed easily. Precipitated protein is recovered in water or an assay-compatible buffer and then assayed by any method. Additionally, assays like the Pierce Detergent Compatible Bradford assay contain proprietary additives that make the assay compatible with 1% or higher of 11 detergents and lysis reagents that are commonly used in life science research, including Triton™ X-100, Tween™ 20, and NP-40 detergents.

Table 7. Some of the interfering substances removed by Compat-Able reagents. In one round of treatment, Compat-Able reagents can remove most any interfering substance, including but not limited to those in this table. If concentrations of these or other interfering components exceed the listed levels, more than one round of pretreatment can be performed.

Laemmli buffer	5% Tween 20
3.0 M Tris	125 mM sodium citrate
20% glycerol	200 mM sodium acetate
4% SDS	200 mM EDTA
5% 2-mercaptoethanol	1.0 M imidazole
3.6 M magnesium chloride	200 mM glucose
1.25 M sodium chloride	
350 mM dithiothreitol (DTT)	
5% Triton X-100	

Table 8 (pages 15–17) presents a summary of compatible substances with a variety of Pierce protein assays. An extensive list of substances that have been tested for compatibility with each protein assay reagent also can be found in the instruction booklet that accompanies each assay product. A copy can also be obtained from our website.

Table 8. Substances compatible with Pierce protein assays. Concentrations listed refer to the actual concentration in the protein sample.

A blank indicates that the material is incompatible with the assay; NA indicates the substance has not been tested in that assay. Ø denotes compounds that were not compatible at the lowest concentration tested. Compounds are listed alphabetically using common names or abbreviations, except sodium compounds, which are alphabetized under “Na”. Dilutions are expressed as undiluted or in the form of a ratio, where “1:2” means 2-fold dilution.

Test compound	Pierce Rapid Gold BCA	Pierce BCA	Pierce Microplate BCA-RAC*	Pierce Micro BCA	Pierce Modified Lowry	Pierce Detergent Compatible Bradford	Pierce Coomassie Plus	Pierce Coomassie	Pierce 660 nm
2D sample buffer**	NA	NA	NA	NA	NA	NA	NA	NA	Undiluted**
2-mercaptoethanol	Ø	0.01%	25 mM (35)	1 mM	1 mM	1 M	1 M	1 M	1 M
ACES, pH 7.8	25 mM	25 mM	Ø	10 mM	NA	NA	100 mM	100 mM	50 mM
Acetone	10%	10%	Ø	1%	10%	10%	10%	10%	50%
Acetonitrile	10%	10%	30%	1%	10%	10%	10%	10%	50%
Ammonium sulfate	Ø	1.5 M	Ø	Ø	Ø	1 M	1 M	1 M	125 mM
Aprotinin	10 mg/L	10 mg/L	Ø	1 mg/L	10 mg/L	10 mg/mL	10 mg/L	10 mg/L	2 mM
Ascorbic acid	NA	Ø	NA	Ø	1 mM	50 mM	50 mM	50 mM	500 mM
Asparagine	NA	1 mM	Ø	NA	5 mM	NA	10 mM	10 mM	40 mM
Bicine	20 mM	20 mM	1 mM	2 mM	NA	100 mM	100 mM	100 mM	>1 M
Bis-Tris pH 6.5	NA	33 mM	16.5 mM	0.2 mM	NA	100 mM	100 mM	100 mM	50 mM
Borate (50 mM) pH 8.5	Undiluted	Undiluted	Ø	1:4	NA	Undiluted	Undiluted	Undiluted	Undiluted
B-PER Reagent	Undiluted	Undiluted	1:3	NA	NA	Undiluted	1:2	1:2	1:2
B-PER Reagent II	NA	NA	1:4	NA	NA	NA	1:4	NA	1:2
B-PER Reagent PBS	NA	NA	1:4	NA	NA	Undiluted	NA	NA	1:2
Brij-35	5%	5%	0.63%	5%	0.031%	1%	0.062%	0.125%	5%
Brij-56	NA	1%	NA	1%	0.062%	NA	0.031%	0.031%	NA
Brij-58	1%	1%	0.50%	1%	0.062%	1%	0.016%	0.031%	5%
Bromophenol blue (in 50 mM NaOH)	Ø	Ø	Ø	Ø	Ø	NA	Ø	Ø	0.031%
Calcium chloride (in TBS pH 7.2)	10 mM	10 mM	1 mM	10 mM	NA	10 mM	10 mM	10 mM	40 mM
Cesium bicarbonate	NA	100 mM	Ø	100 mM	50 mM	NA	100 mM	100 mM	100 mM
Cetylpyridinium chloride	NA	NA	NA	NA	NA	NA	NA	NA	2.5%**
CHAPS	5%	5%	10% (10)	1%	0.062%	5%	5%	5%	5%
CHAPSO	5%	5%	Ø	5%	0.031%	5%	5%	5%	4%
CHES	100 mM	100 mM	50 mM	100 mM	NA	NA	100 mM	100 mM	>500 mM
Cobalt chloride (in TBS pH 7.2)	0.8 mM	0.8 mM	0.4 mM	Ø	NA	NA	10 mM	10 mM	20 mM
CTAB	NA	NA	NA	NA	NA	NA	NA	NA	2.5%**
Cysteine	NA	Ø	2.5 mM	Ø	1 mM	10 mM	10 mM	10 mM	350 mM
Dithioerythritol (DTE)	NA	1 mM	2.5 mM	Ø	Ø	NA	1 mM	1 mM	25 mM
Dithiothreitol (DTT)	Ø	1 mM	5 mM (5)	Ø	Ø	5 mM	5 mM	5 mM	500 mM
DMF	10%	10%	5%	1%	10%	10%	10%	10%	50%
DMSO	10%	10%	0.25%	1%	10%	10%	10%	10%	50%
DTAB	NA	NA	NA	NA	NA	NA	NA	NA	2%**
EDTA	10 mM	10 mM	5 mM (20)	0.5 mM	1 mM	100 mM	100 mM	100 mM	20 mM
EGTA	NA	Ø	5 mM (10)	Ø	1 mM	2 mM	2 mM	2 mM	20 mM
EPPS pH 8.0	100 mM	100 mM	Ø	100 mM	NA	NA	100 mM	100 mM	200 mM
Ethanol	10%	10%	Ø	1%	10%	10%	10%	10%	50%
Ferric chloride (in TBS pH 7.2)	10 mM	10 mM	5 mM	0.5 mM	NA	NA	10 mM	10 mM	5 mM
Glucose	10 mM	10 mM	Ø	1 mM	100 mM	NA	1 mM	1 mM	500 mM
Glutathione (reduced)	NA	NA	10 mM	NA	NA	NA	NA	NA	100 mM
Glycerol (fresh)	10%	10%	5%	1%	10%	10%	10%	10%	50%
Glycine-HCl pH 2.8	100 mM	100 mM	50 mM	NA	100 mM	100 mM	100 mM	100 mM	100 mM

* Selected values for the regular Pierce BCA – Reducing Agent Compatible (RAC) Kit are given in parentheses in the column for the microplate BCA-RAC kit. ** Value when the Pierce 660 nm assay is run using the Thermo Scientific™ Ionic Detergent Compatibility Reagent (IDCR, Cat. No. 22663). † Compound (buffer) formulation is described more fully in Table 9.

Table 8. Substances compatible with Pierce protein assays. (continued)

Test compound	Pierce Rapid Gold BCA	Pierce BCA	Pierce Microplate BCA-RAC*	Pierce Micro BCA	Pierce Modified Lowry	Pierce Detergent Compatible Bradford	Pierce Coomassie Plus	Pierce Coomassie	Pierce 660 nm
Guanidine-HCl	4 M	4 M	1.5 M (2)	4 M	NA	1.25 M	3.5 M	3.5 M	2.5 M
HEPES pH 7.5	100 mM	100 mM	200 mM (200)	100 mM	1 mM	100 mM	100 mM	100 mM	100 mM
Hydrides (Na ₂ BH ₄ or NaCNBH ₃)	NA	∅	NA	∅	NA	NA	NA	NA	∅
Hydrochloric acid (HCl)	100 mM	100 mM	∅	10 mM	100 mM	100 mM	100 mM	100 mM	125 mM
Imidazole pH 7.0	12.5 mM	50 mM	30 mM (50)	12.5 mM	25 mM	200 mM	200 mM	200 mM	200 mM
I-PER Reagent	Undiluted	Undiluted	NA	NA	NA	NA	NA	NA	1:4
Laemmli SDS sample buffer†	∅	∅	∅	∅	∅	NA	∅	∅	∅
Leupeptin	10 mg/L	10 mg/L	∅	10 mg/L	10 mg/L	10 mg/L	10 mg/L	10 mg/L	80 µM
Mannitol	NA	NA	NA	NA	NA	NA	NA	NA	100 mM
Melibiose	NA	∅	NA	NA	25 mM	NA	100 mM	100 mM	500 mM
Mem-PER Reagent	Undiluted	Undiluted	1:2	Undiluted	NA	NA	Undiluted	NA	Undiluted
Mem-PER Plus Reagent	Undiluted	Undiluted	NA	Undiluted	NA	Undiluted	NA	NA	Undiluted
MES-buffered saline pH 4.7	Undiluted	Undiluted	∅	1:4	NA	Undiluted	Undiluted	Undiluted	Undiluted
MES pH 6.1	100 mM	100 mM	100 mM (100)	100 mM	125 mM	100 mM	100 mM	100 mM	125 mM
Methanol	NA	10%	0.5%	1%	10 %	10%	10%	10%	50%
Magnesium chloride	NA	NA	100 mM	NA	NA	500 mM	NA	NA	> 1M
Modified Dulbecco's PBS†	NA	Undiluted	Undiluted	Undiluted	NA	Undiluted	Undiluted	Undiluted	Undiluted
MOPS pH 7.2	100 mM	100 mM	200 mM	100 mM	NA	100 mM	100 mM	100 mM	125 mM
M-PER Reagent	Undiluted	Undiluted	1:2	NA	NA	Undiluted	Undiluted	NA	1:2
N-acetylglucosamine	10 mM	10 mM	∅	∅	NA	NA	100 mM	100 mM	100 mM
Na (sodium) acetate pH 4.8	200 mM	200 mM	∅	200 mM	200 mM	180 mM	180 mM	180 mM	100 mM
Na azide	0.2%	0.2%	0.01%	0.20%	0.2%	0.5%	0.5%	0.5%	0.125%
Na bicarbonate	100 mM	100 mM	∅	100 mM	100 mM	100 mM	100 mM	100 mM	100 mM
Na carbonate-bicarbonate pH 9.4†	NA	Undiluted	Undiluted	Undiluted	NA	Undiluted	Undiluted	Undiluted	1:3
Na chloride	NA	1 M	150 mM	1 M	1 M	1 M	5 M	5 M	1.25 M
Na citrate pH 4.8	200 mM	200 mM	50 mM	5 mM	NA	200 mM	200 mM	200 mM	12.5 mM
Na citrate-carbonate pH 9†	1:8	1:8	∅	1:600	NA	NA	Undiluted	Undiluted	∅
Na citrate-MOPS pH 7.5†	1:8	1:8	Undiluted	1:600	NA	NA	NA	Undiluted	1:16
Na deoxycholate (DOC)	5%	5%	NA	5%	NA	0.1%	0.4%	0.05%	0.25%
Na hydroxide (NaOH)	100 mM	100 mM	∅	50 mM	100 mM	75 mM	100 mM	100 mM	125 mM
Na phosphate	100 mM	100 mM	100 mM	100 mM	100 mM	100 mM	100 mM	100 mM	500 mM
NE-PER Reagent (CER)	1:2	Undiluted	1:2	NA	NA	Undiluted	1:4	NA	Undiluted
NE-PER Reagent (NER)	Undiluted	Undiluted	1:4	NA	NA	NA	Undiluted	NA	Undiluted
Nickel chloride (in TBS pH 7.2)	NA	10 mM	∅	0.2 mM	NA	NA	10 mM	10 mM	10 mM
NP-40	5%	5%	∅	5%	0.016%	1%	0.5%	0.5%	5%
Octyl beta-glucoside	5%	5%	2.5% (10)	0.1%	0.031%	5%	0.5%	0.5%	5%
Octylthioglucoside	NA	5%	7%	5%	NA	5%	3%	3%	10%
Na-orthovanadate (in PBS pH 7.2)	1 mM	1 mM	0.5 mM	1 mM	NA	NA	1 mM	1 mM	50 mM
Phenol red	NA	∅	3.125 µg/mL	∅	NA	0.5 mg/mL	0.5 mg/mL	0.5 mg/mL	0.5 mg/mL

* Selected values for the regular Pierce BCA – Reducing Agent Compatible (RAC) Kit are given in parentheses in the column for the microplate BCA-RAC kit. ** Value when the Pierce 660 nm assay is run using the Thermo Scientific™ Ionic Detergent Compatibility Reagent (IDCR, Cat. No. 22663). † Compound (buffer) formulation is described more fully in Table 9.

Table 8. Substances compatible with Pierce protein assays. (continued)

Test compound	Pierce Rapid Gold BCA	Pierce BCA	Pierce Microplate BCA-RAC*	Pierce Micro BCA	Pierce Modified Lowry	Pierce Detergent Compatible Bradford	Pierce Coomassie Plus	Pierce Coomassie	Pierce 660 nm
Phosphate-buffered saline (PBS) [†]	Undiluted	Undiluted	Undiluted	Undiluted	NA	Undiluted	Undiluted	Undiluted	Undiluted
PIPES pH 6.8	NA	100 mM	25 mM	100 mM	NA	NA	100 mM	100 mM	100 mM
PMSF in isopropanol	1 mM	1 mM	0.125 mM	1 mM	1 mM	1 mM	1 mM	1 mM	1 mM
Potassium thiocyanate	3 M	3 M	∅	NA	100 mM	NA	3 M	3 M	250 mM
P-PER Reagent	NA	∅	1:2	NA	∅	NA	∅	∅	1:2
RIPA buffer [†]	Undiluted	Undiluted	1:2	1:10	NA	1:4	1:40	1:10	Undiluted
SDS	5%	5%	5% (10)	5%	1%	0.5%	0.016%	0.125%	0.01%, 5%**
Span 20	0.5%	1%	NA	1%	0.25%	NA	0.5%	0.5%	NA
Sucrose	40%	40%	40% (40)	4%	7.5%	10%	10%	10%	50%
TCEP	NA	NA	10 mM (10)	NA	NA	100 mM	NA	NA	40 mM
Thimerosal	NA	0.01%	0.03%	∅	0.01%	NA	0.01%	0.01%	0.25%
Thiourea	NA	NA	NA	NA	NA	NA	NA	NA	2 M
TLCK	0.1 mg/L	0.1 mg/L	∅	0.1 mg/L	0.01 mg/L	NA	0.1 mg/mL	0.1 mg/L	5 mg/mL
TPCK	0.1 mg/L	0.1 mg/L	∅	0.1 mg/L	0.1 mg/L	NA	0.1 mg/mL	0.1 mg/L	4 mg/mL
T-PER Reagent	1:2	1:2	NA	NA	NA	Undiluted	Undiluted	NA	1:2
Tricine pH 8.0	25 mM	25 mM	0.5 mM	2.5 mM	NA	NA	100 mM	100 mM	500 mM
Triethanolamine pH 7.8	25 mM	25 mM	25 mM	0.5 mM	NA	NA	100 mM	100 mM	100 mM
Tris-buffered saline (TBS) [†]	Undiluted	Undiluted	Undiluted	1:10	NA	Undiluted	Undiluted	Undiluted	Undiluted
Tris-glycine pH 8.0 [†]	1:2	1:3	∅	1:10	NA	Undiluted	Undiluted	Undiluted	Undiluted
Tris-glycine-SDS pH 8.3 [†]	Undiluted	Undiluted	∅	Undiluted	NA	Undiluted	1:4	1:2	Undiluted**
Tris-HCl pH 8.0	∅	250 mM	35 mM (50)	50 mM	10 mM	2 M	2 M	2 M	250 mM
Tris-HEPES-SDS [†]	100 mM	NA	NA	NA	NA	NA	NA	NA	Undiluted**
Triton X-100	5%	5%	7% (10)	5%	0.031%	1%	0.062%	0.125%	1%
Triton X-114	1%	1%	2% (2)	0.05%	0.031%	1%	0.062%	0.125%	0.50%
Triton X-305	1%	1%	1%	1%	0.031%	NA	0.125%	0.5%	9%
Triton X-405	1%	1%	∅	1%	0.031%	NA	0.025%	0.5%	5%
Tween 20	5%	5%	10% (10)	5%	0.062%	1%	0.031%	0.062%	10%
Tween 60	5%	5%	5%	0.5%	NA	NA	0.025%	0.1%	5%
Tween 80	5%	5%	2.5%	5%	0.031%	0.1%	0.016%	0.062%	5%
Urea	3 M	3 M	3 M (4)	3 M	3 M	3 M	3 M	3 M	8 M
Y-PER Reagent	∅	Undiluted	NA	NA	NA	NA	NA	NA	∅
Y-PER Plus Reagent	∅	Undiluted	NA	NA	NA	Undiluted	Undiluted	NA	1:2
Zinc chloride (in TBS pH 7.2)	10 mM	10 mM	∅	0.5 mM	NA	NA	10 mM	10 mM	10 mM
Zwittergent 3-14	NA	1%	2% (2)	∅	NA	NA	0.025%	0.025%	0.05%

Table 9. Buffer formulations used in compatibility testing.

Buffer	Formulation	Cat. No.
2D sample buffer	(8 M urea, 4% CHAPS) or (7 M urea, 2 M thiourea, 4% CHAPS)	–
Laemmli SDS sample buffer	65 mM Tris-HCl, 10% glycerol, 2% SDS, 0.025% bromophenol blue	–
MES-buffered saline pH 4.7	0.1 M MES, 150 mM NaCl pH 4.7	28390
Modified Dulbecco's PBS	8 mM sodium phosphate, 2 mM potassium phosphate, 0.14 M NaCl, 10 mM KCl, pH 7.4	28374
Na carbonate-bicarbonate pH 9.4	0.2 M sodium carbonate-bicarbonate pH 9.4	28382
Na citrate-carbonate pH 9.0	0.6 M sodium citrate, 0.1 M sodium-carbonate pH 9.0	–
Na citrate-MOPS pH 7.5	0.6 M sodium citrate, 0.1 M MOPS pH 7.5	–
Phosphate-buffered saline (PBS)	100 mM sodium phosphate, 150 mM NaCl pH 7.2	28372
RIPA buffer	50 mM Tris, 150 mM NaCl, 0.5% DOC, 1% NP-40, 0.1% SDS pH 8.0	89900
Tris-buffered saline (TBS)	25 mM Tris, 150 mM NaCl pH 7.6	28379
Tris-glycine pH 8.0	25 mM Tris, 192 mM glycine pH 8.0	28380
Tris-glycine-SDS pH 8.3	25 mM Tris, 192 mM glycine, 0.1% SDS pH 8.3	28378
Tris-HEPES-SDS	100 mM Tris, 100 mM HEPES, 3 mM SDS	28398

Time considerations

The amount of time required to complete a total protein assay will vary for the different colorimetric total protein assay methods presented. To compare the amount of time required to perform each assay, all nine assays were performed using 20 samples and eight standards (including the blank) (Table 10). Each sample or standard was assayed in duplicate using the standard tube protocol (triplicate using the plate). The estimates include times for both incubation(s) and handling:

- Preparing (diluting) the standard protein in the diluent buffer (10 minutes)
- Organizing the run and labeling the tubes (5 minutes)
- Pipetting the samples and reagents (10 minutes for 56 tubes, 1 minute per plate)
- Mixing or incubating the tubes or plates (varies)
- Measuring the color produced (15 minutes for 56 tubes or 1 minute per plate)
- Graphing the standard curve, calculating, recording, and reporting the results (30 minutes)

Table 10. Total assay time for Pierce protein assays. Times required to assay 20 samples and 8 standards using the test tube procedure; handling times are considerably less using the microplate procedure.

Method	Cat. No.	Incubation time (min)	Total assay time (min)
Pierce Rapid Gold BCA assay	A53225	5	50
Pierce BCA assay	23225	30	100
Pierce Micro BCA assay	23235	60	130
Pierce BCA Protein Assay–Reducing Agent Compatible assay	23250	45	115
Pierce Modified Lowry assay	23240	10 and 30	110
Pierce Detergent Compatible assay	23246	10	50
Pierce Coomassie Plus (Bradford) assay	23236	10	80
Pierce Coomassie (Bradford) assay	23200	10	80
Pierce 600 nm protein assay	23250	5	75

Calculation of results

When calculating protein concentrations manually, it is best to use point-to-point interpolation. This is especially important if the standard curve is nonlinear. Point-to-point interpolation refers to a method of calculating the results for each sample using the equation for a linear regression line obtained from just two points on the standard curve. The first point is the standard that has an absorbance just below that of the sample, and the second point is the standard that has an absorbance just above that of the sample. In this way, the concentration of each sample is calculated from the most appropriate section of the whole standard curve. Determine the average total protein concentration for each sample from the average of its replicates. If multiple dilutions of each sample have been assayed, average the results for the dilutions that fall within the most linear portion of the working range.

When analyzing results with a computer, use a quadratic curve fit for the nonlinear standard curve to calculate the protein concentration of the samples. If the standard curve is linear, or if the absorbance readings for your samples fall within the linear portion of the standard curve, the total protein concentrations of the samples can be estimated using the linear regression equation.

Most software programs allow one to construct and print a graph of the standard curve, calculate the protein concentration for each sample, and display statistics for the replicates. Typically, the statistics displayed will include the mean absorbance readings (or the average of the calculated protein concentrations), the standard deviation (SD), and the coefficient of variation (CV) for each standard or sample. If multiple dilutions of each sample have been assayed, average the results for the dilutions that fall in the most linear portion of the working range.

Related references

Krohn RI (2002) The colorimetric detection and quantitation of total protein. In: *Current Protocols in Cell Biology*. John Wiley & Sons, Inc. pp A3.H.1–A.3H.28.

Krohn RI (2001) The colorimetric determination of total protein. In: *Current Protocols in Food Analytical Chemistry*. John Wiley & Sons, Inc. pp B1.1.1–B1.1.27.

Copper-based total protein assays

Copper-based protein assays, including the bicinchoninic acid (BCA) and Lowry methods, depend on the well-known biuret reaction as a first step. In the biuret reaction, peptides containing three or more amino acid residues form a colored chelate complex with cupric ions (Cu^{2+}) in an alkaline environment containing sodium potassium tartrate. Biuret, a product of excess urea and heat, reacts with copper to form a light blue tetradentate complex. Upon the addition of a second reagent, which differs between the BCA and Lowry methods, the color is enhanced, increasing the sensitivity of the biuret reaction.



BCA-based protein assays

In 1985, Paul K. Smith et al. introduced the BCA protein assay [1]. Since then it has become a very popular method for colorimetric detection and quantitation of total protein. The BCA protein assay has a unique advantage over the modified Lowry protein assay and any of the Coomassie dye-based assays—it is compatible with samples that contain up to 5% surfactants (detergents).

Briefly, the sample is added to the tube or plate containing the prepared BCA working reagent, and after a 30-minute incubation at 37°C and cooling to room temperature, the resultant purple color is measured at 562 nm. The protocol is similar for the Pierce Micro BCA protein assay, a modified version of the standard BCA assay for quantification of low-concentration protein samples. The Pierce Micro BCA assay uses a different ratio of sample volume to working reagent, and the tubes are incubated for 60 minutes at 60°C. The new Pierce Rapid Gold BCA Assay Kit provides the same, reliable and trusted accuracy of the traditional Pierce BCA assay, but in a fraction of the time and in a room-temperature environment.

Chemistry of BCA-based protein assays

The Pierce BCA protein assay combines the well-known reduction of Cu^{2+} to Cu^+ by protein in an alkaline medium (also known as the biuret reaction) with the highly sensitive and selective colorimetric detection of the cuprous cation (Cu^+) by bicinchoninic acid (Figure 1). The first step is the chelation of copper with protein in an alkaline environment to form a blue-colored complex. In this reaction, peptides containing three or more amino acid residues form a colored chelate complex with cupric ions in an alkaline environment containing sodium potassium tartrate. This became known as the biuret reaction because a similar complex forms with the organic compound biuret ($\text{NH}_2\text{-CO-NH-CO-NH}_2$) and the cupric ion. Biuret, a product of excess urea and heat, reacts with copper to form a light blue tetradentate complex (Figure 2). Single amino acids and dipeptides are unaffected in the biuret reaction, but tripeptides and larger polypeptides or proteins will react to produce the light blue-to-violet complex that absorbs light at 540 nm. One cupric ion forms a colored coordination complex with four to six nearby peptide bonds. The intensity of the color produced is proportional to the number of peptide bonds participating in the reaction. Thus, the biuret reaction is the basis for a simple and rapid

colorimetric reagent of the same name for quantitatively determining total protein concentration. Since the working range for the biuret assay is 5–160 mg/mL, the biuret assay is used in clinical research laboratories for the quantitation of total protein in serum.

Step 1.



Step 2.

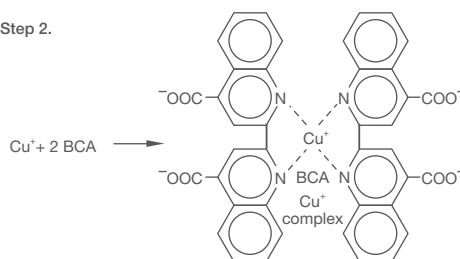

Figure 1. Reaction schematic the bicinchoninic acid (BCA)-containing protein assay.

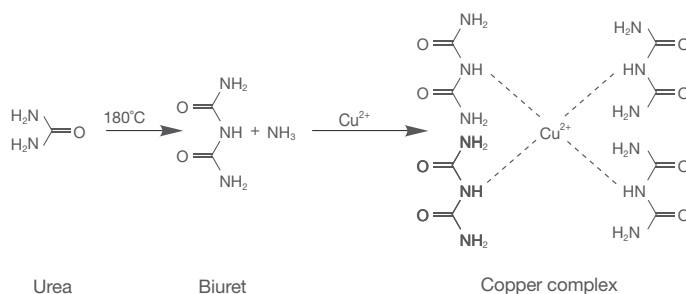

Figure 2. Biuret reaction schematic.

In the second step of the color development reaction, BCA reagent, a highly sensitive and selective colorimetric detection reagent, reacts with the cuprous cation (Cu^+) that was formed in the first step. The purple-colored reaction product is formed by the chelation of two molecules of BCA reagent with one cuprous ion (Figure 1). The BCA–copper complex is water-soluble and exhibits a strong linear absorbance at 562 nm with increasing protein concentrations. The purple color may be measured at any wavelength between 550 and 570 nm with minimal (less than 10%) loss of signal. The signal induced by the BCA reagent is approximately 100 times more sensitive (lower limit of detection) than the signal using the biuret reagent. The reaction that leads to BCA color formation is also strongly influenced by the presence of any of four amino acid residues (cysteine, cystine, tyrosine, and tryptophan) in the protein.

Unlike the Coomassie dye-binding methods that require a minimum mass of protein to be present for the dye to bind, the presence of only a single cysteine, tyrosine, or tryptophan amino acid residue in the sample may result in the formation of a colored BCA–Cu⁺ chelate. Studies performed with di- and tripeptides indicate that the total amount of color produced is greater than can be accounted for by the color produced by each BCA reagent–reactive amino acid. Therefore, the peptide backbone must contribute to the reduction of copper as well.

The Pierce Rapid Gold BCA protein assay uses the same copper reduction method as traditional Pierce BCA assay with a proprietary copper chelator. The Pierce Rapid Gold BCA assay combines the well-known reduction of Cu²⁺ to Cu⁺ by protein in an alkaline medium with the highly sensitive and selective colorimetric detection of the cuprous cation (Cu⁺) by the proprietary chelator. The first step is the chelation of copper with protein in an alkaline environment to form a light green complex. In this reaction, known as the biuret reaction, peptides containing three or more amino acid residues form a colored chelate complex with cupric ions in an alkaline environment containing sodium potassium tartrate.

In the second step of the color development reaction, the Pierce Rapid Gold BCA chelator reacts with the reduced (cuprous) cation (Cu⁺) that was formed in step one. The intensely gold-colored reaction product results from the chelation of two molecules of BCA with one cuprous ion. The BCA–copper complex is water-soluble and exhibits a strong linear absorbance at 480 nm with increasing protein concentrations. The BCA reagent is approximately 100 times more sensitive (lower limit of detection) than the pale green color of the first reaction.

The reaction that leads to the color formation is strongly influenced by four amino acid residues (cysteine or cystine, tyrosine, and tryptophan) in the amino acid sequence of the protein. However, unlike the Coomassie dye–binding methods, the universal peptide backbone also contributes to color formation, helping to minimize variability caused by protein compositional differences.

The rate of BCA color formation is dependent on the incubation temperature, the types of protein present in the sample, and the relative amounts of reactive amino acids contained in the proteins. The BCA reaction does not represent an endpoint assay—the incubation periods were

chosen to yield maximal color response in a reasonable time frame.

Advantages of the BCA protein assay

The primary advantage of the Pierce BCA Protein Assay Kit is its compatibility with most surfactants—even if present in the sample at concentrations up to 5%. In addition, the protein–protein variation of the Pierce BCA protein assay is relatively low and is similar to that observed for the Pierce Modified Lowry protein assay (Table 6, page 13).

Additional advantages of the BCA protein assay include assay linearity, flexibility, and ease-of-use. The Pierce BCA protein assay produces a linear response curve ($R^2 > 0.95$) and can be performed using two different formats based upon the dynamic range needed to detect the protein concentration of an unknown sample. The standard Pierce BCA protein assay (Figure 3) detects protein concentrations from 20 to 2,000 µg/mL using a two-component system: Reagent A, a carbonate buffer containing BCA reagent, and Reagent B, a cupric sulfate solution, which are combined to make an apple green–colored working solution that turns purple after 30 minutes at 37°C in the presence of protein. The Pierce Micro BCA Protein Assay Kit consists of three components—BCA Reagents A, B, and C that are combined to make a working solution that turns purple in the presence of protein after 1 hour at 60°C. Both assays measure the amount of color at 562 nm using a standard spectrophotometer and are less complicated to perform than the Lowry protein assay.

Since the color reaction is not a true endpoint reaction, considerable protocol flexibility is allowed with the Pierce BCA protein assay. By increasing the incubation temperature, the sensitivity of the assay can be increased. When using the enhanced tube protocol (i.e., incubating at 60°C for 30 minutes), the working range for the assay shifts to 5–250 µg/mL, facilitating detection of more dilute samples.

Recently, a new formulation of BCA was developed, the Pierce Rapid Gold BCA Protein Assay Kit. This assay uses the same copper-chelating technology as the traditional Pierce BCA assay and provides comparable accuracy but in only 5 minutes using a room-temperature incubation. This improvement eliminates the need to wait or expose the samples to elevated temperatures.

A final advantage of these BCA-based protein assays is that it produces less protein–protein variation than the Coomassie dye–based assays. The color response obtained for a seven-point standard curve with the standard Pierce BCA and Pierce Rapid Gold BCA protein assays using BSA or BGG standards shows less than 20% variation between these two proteins (Figure 3 and 4). In comparison, the Coomassie assay demonstrates >30% variation in the signal generated between BSA and BGG (Table 6, page 13). There is even less variation (<12%) when comparing these protein standards with the Pierce Micro BCA protein assay (Figure 5). In summary, Pierce BCA protein assays provide one of the most accurate measurements of protein concentration in biological samples, are detergent compatible, and are simple to perform.

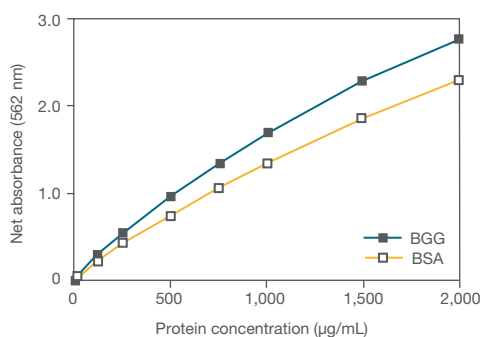

Figure 3. Color response curves obtained with the Pierce BCA protein assay using BSA and BGG. The standard tube protocol was performed, and the color was measured at 562 nm.

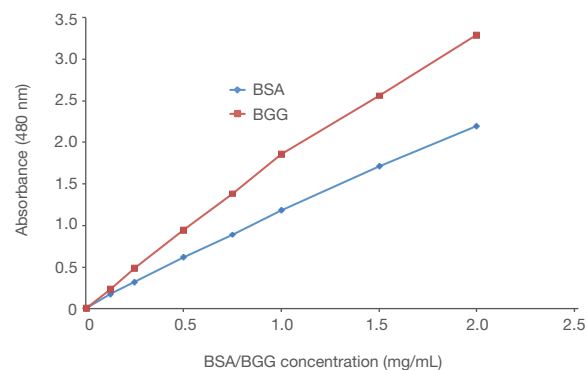

Figure 4. Color response curves obtained with the Pierce Rapid Gold BCA protein assay using BSA and BGG. The microplate protocol was performed, and the color was measured at 480 nm.

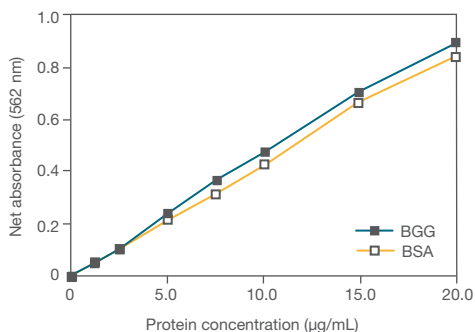

Figure 5. Color response curves obtained with the Pierce Micro BCA protein assay using BSA and BGG. The standard tube protocol was performed, and the color was measured at 562 nm.

Disadvantages of the BCA protein assay

Substances that reduce copper will also produce color in the BCA assay, disrupting the accuracy of the protein quantitation. Other substances that will interfere with the BCA assay include reagents that chelate copper, common reducing agents such as DTT, and specific single amino acids that also produce color in the BCA assay (cysteine or cystine, tyrosine, and tryptophan). Some additional disadvantages of the standard BCA assay are related to the time and incubation temperatures (37°C or 60°C) necessary to achieve optimal sensitivity. The new Pierce Rapid Gold BCA assay eliminated this disadvantage because of the short incubation time (5 minutes) at room temperature. In addition, colorimetric assays are typically shorter and can be incubated at room temperature.

Reference

1. Smith PK et al. (1985). Measurement of protein using bicinchoninic acid. *Anal Biochem* 150(1):76–85.

Pierce Rapid Gold BCA Protein Assay Kit



The Pierce Rapid Gold BCA Protein Assay Kit is a two-component, high-precision, detergent-compatible assay optimized to measure total protein concentration at 480 nm compared to a protein standard curve of known concentrations. The Pierce Rapid Gold BCA protein assay uses the same copper-chelating technology as the well-known traditional Pierce BCA assay and provides comparable accuracy but in only 5 minutes using a room-temperature incubation. This improvement eliminates the need to wait or expose the samples to elevated temperatures.

Highlights:

- **Colorimetric**—estimate visually or measure with a standard spectrophotometer or plate reader at 480 nm
- **Excellent uniformity**—exhibits similar protein–protein variation as traditional Pierce BCA protein assay, and less protein–protein variation than dye-binding protein assay methods
- **Compatible**—unaffected by typical concentrations of most ionic and nonionic detergents
- **Fast**—significant improvement over traditional Pierce BCA assay; achieve results in 5 minutes at room temperature (Figure 6)
- **Broad linearity**—linear working range for BSA equals 20–2,000 $\mu\text{g/mL}$
- **Compatible**—reaction produces intense orange-gold color change that shows a strong linear response at 480 nm, providing optimal absorbance on standard spectrophotometers

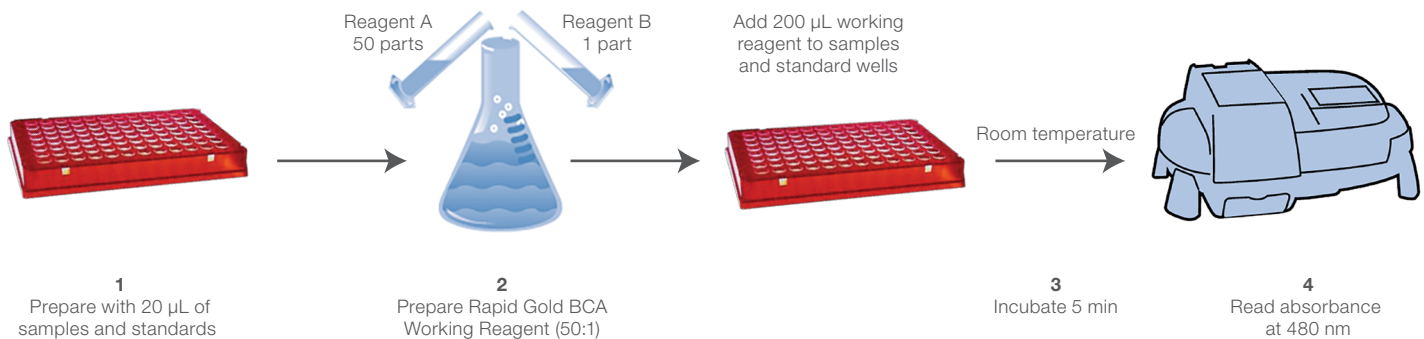

Figure 6. Pierce Rapid Gold BCA protein assay protocol.

The traditional Pierce BCA assay is a widely used and accepted protein assay—trusted for its highly accurate protein concentration determination and compatibility with most sample types encountered in protein research. However, the traditional protocol requires either heating the reaction at 37°C for 30 minutes or continue the reaction at room temperature (RT) for 2 hours for maximum color development. The Pierce Rapid Gold BCA assay is a dramatic improvement from the Pierce BCA assay, maintaining the key characteristics of the traditional BCA assay, while allowing a rapid, room-temperature incubation similar to the dye-binding methods such as the Bradford assay (Figure 7). The Pierce Rapid Gold BCA assay can be used to assess yields in whole cell lysates (Figure 8) and affinity-column fractions, as well as to monitor protein contamination in industrial applications. Compared to most dye-binding methods, the Pierce Rapid Gold BCA assay is affected much less by protein compositional differences, providing low protein–protein variation, much like the traditional Pierce BCA assay.

Protein assays using a copper chelator are found to be highly advantageous because most surfactants (even if present in the sample at concentrations up to 5%) are compatible with the assay. Thermo Fisher Scientific has performed extensive compatibility experiments on all of our protein assays, in particular for the traditional Pierce BCA assay (see Table 8, pages 15–17). The Pierce Rapid Gold BCA assay and traditional BCA assay were determined to have similar compatibility with the interfering substances as traditional BCA.

Applications:

- Studying protein–protein interactions
- Measuring column fractions after affinity chromatography purification
- Estimating percent recovery of membrane proteins from cell extracts
- High-throughput screening of fusion proteins

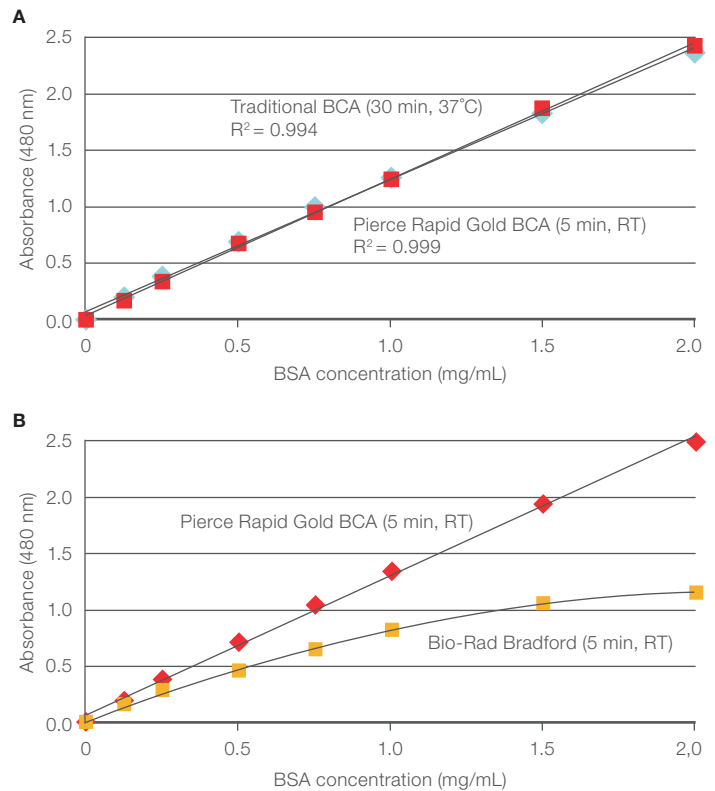

Figure 7. Standard curves for protein quantitation assays. (A) Pierce Rapid Gold BCA assay and the Pierce BCA assay standard curves were produced using purified BSA in 0.9% saline (0–2 mg/mL). Both assays were conducted according to the manufacturer’s protocols in a microplate format. For the BCA assay, 25 μ L BSA sample was added to 200 μ L BCA reagent and incubated for 30 minutes at 37°C. For the Pierce Rapid Gold BCA assay, 20 μ L BSA sample was added to 200 μ L Pierce Rapid Gold BCA reagent and incubated at room temperature for 5 minutes. (B) Pierce Rapid Gold BCA and Bio-Rad Bradford assay standard curves were produced with purified BSA in 0.9% saline (0–2 mg/mL).

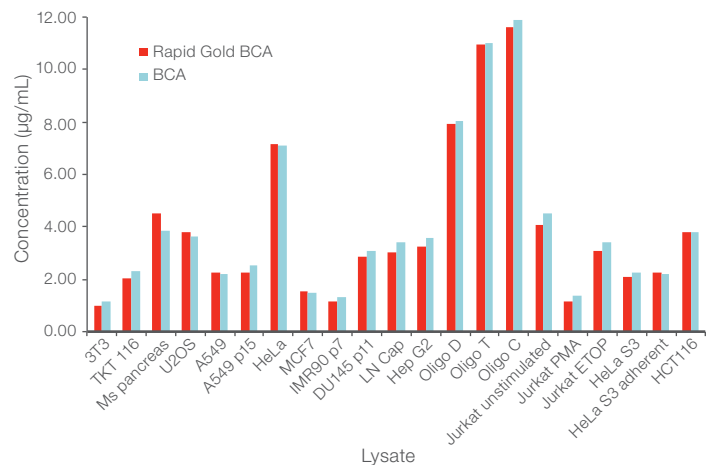

Figure 8. Concentration determination of lysates using the standard BCA assay and Pierce Rapid Gold BCA assay. Both assays were conducted according to manufacturer’s protocols using a microplate format. For the BCA assay, 25 μ L BSA sample was added to 200 μ L BCA reagent and incubated for 30 minutes at 37°C. For the Pierce Rapid Gold BCA assay, 20 μ L BSA sample was added to 200 μ L Pierce Rapid Gold BCA reagent and incubated at room temperature for 5 minutes.

Pierce BCA Protein Assay Kit



The Pierce BCA Protein Assay Kit enables the measurement of total protein concentration compared to a protein standard and is one of the most popular detergent-compatible protein assays available. The two-component system provides accurate determination of protein concentration with most protein sample types using a simple protocol (Figure 9). Compared to most dye-binding methods, the Pierce BCA assay is affected much less by protein composition differences, providing greater protein-to-protein uniformity. The Pierce BCA assay can be used to assess yields in whole cell lysates and affinity-column fractions, as well as to monitor protein contamination in industrial applications.

Highlights:

- **Colorimetric**—estimate visually or measure with a standard spectrophotometer or plate reader at 562 nm
- **Excellent uniformity**—exhibits less protein-to-protein variation than dye-binding methods
- **Compatible**—assay is unaffected by typical concentrations of most ionic and nonionic detergents
- **Improved speed**—assay is much easier and up to 4 times faster than the classical Lowry method
- **Broad linearity**—linear working range for BSA equals 20–2,000 µg/mL
- **Sensitive**—detect down to 5 µg/mL with the enhanced protocol
- **Multiple assay formats**—choose either a microplate or cuvette assay format

Related references

- Smith PK et al. (1985) Measurement of protein using bicinchoninic acid. *Anal Biochem* 150:76–85.
- Sorensen K (1992) One reagent simultaneously identifies the salt and the protein peaks on desalting column. *BioTechniques* 12(2):235–236.
- Ju T et al. (2002) Cloning and expression of human core 1 beta1,3-galactosyltransferase. *J Biol Chem* 277:178–186.
- Hinson DL, Webber RJ (1988) Miniaturization of the BCA protein assay. *Biotechniques* 6(1):14–19.
- Akins RE, Tuan RS (1992) Measurement of protein in 20 seconds using a microwave BCA assay. *Biotechniques* 12(4):496–499.
- Tyllianakis PE et al. (1994) Direct colorimetric determination of solid-supported functional groups and ligands using bicinchoninic acid. *Anal Biochem* 219(2):335–340.
- Gates RE (1991) Elimination of interfering substances in the presence of detergent in the bicinchoninic acid protein assay. *Anal Biochem* 196(2):290–295.
- Stich TM (1990) Determination of protein covalently bound to agarose supports using bicinchoninic acid. *Anal Biochem* 191:343–346.
- Tuszynski GP, Murphy A (1990) Spectrophotometric quantitation of anchorage-dependent cell numbers using the bicinchoninic acid protein assay reagent. *Anal Biochem* 184(1):189–191.

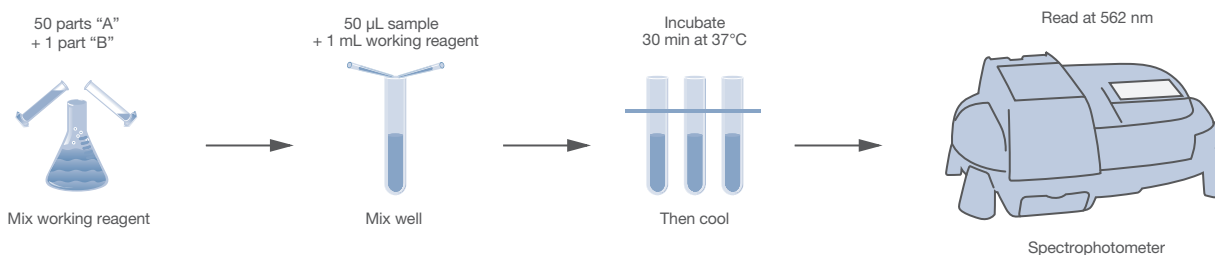

Figure 9. Pierce BCA Protein Assay Kit protocol.

Pierce BCA Protein Assay Kit – Reducing Agent Compatible



The Pierce BCA Protein Assay Kit – Reducing Agent Compatible overcomes some limitations of the original Pierce BCA assay. Although the original Pierce BCA assay is compatible with more detergents, buffers, salts, and solvents than any colorimetric protein assay, the presence of disulfide-reducing agents, including DTT and 2-mercaptoethanol, interferes with the assay. The Pierce BCA Protein Assay Kit – Reducing Agent Compatible provides all the advantages of the original Pierce BCA Protein Assay Kit as well as compatibility with reducing agents at concentrations routinely used in protein sample buffers (Figure 10).

Highlights:

- **Compatible**—assay samples can contain up to 5 mM DTT, 35 mM 2-mercaptoethanol, or 10 mM TCEP
- **BCA technology**—only a slight modification of the standard BCA protein assay protocol is necessary (15-minute incubation with Pierce reducing agent compatible reagent); no precipitation steps required (Figure 11)

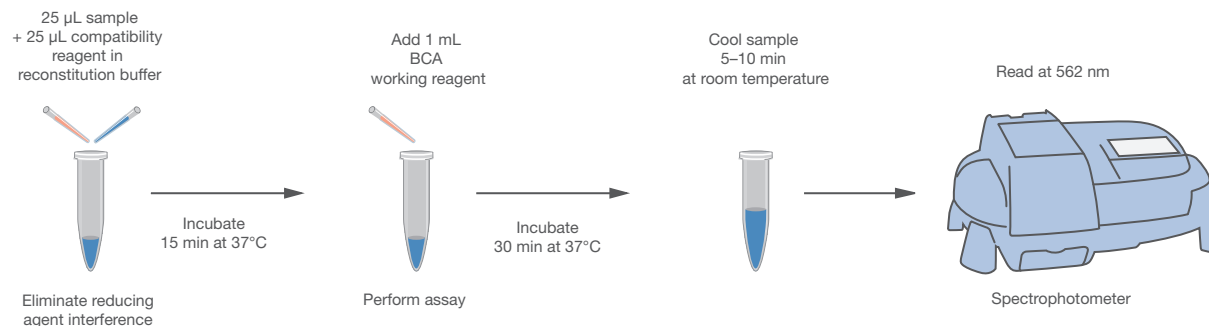

Figure 11. Pierce BCA Protein Assay Kit – Reducing Agent Compatible protocol.

- **Small samples**—requires only 25 μL (standard kit) or less than 10 μL (microplate kit) of sample
- **Colorimetric**—measure with a standard spectrophotometer or plate reader (562 nm)
- **Excellent uniformity**—exhibits less protein-to-protein variation than dye-binding methods
- **Broad linearity**—linear working range for BSA equals 125–2,000 $\mu\text{g}/\text{mL}$

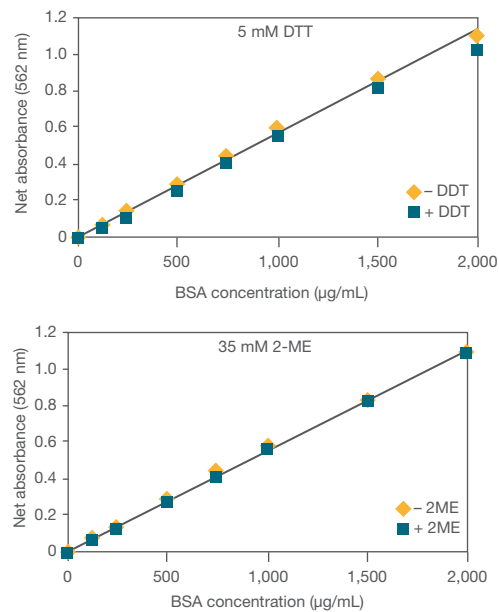

Figure 10. Pierce BCA Protein Assay Kit – Reducing Agent Compatible produces a linear standard curve in the presence of reducing agents. Color response curves for BSA after treatment with Pierce reducing agent compatible reagent in the presence and absence of 5 mM DTT and, 35 mM 2-mercaptoethanol (2-ME).

Pierce Micro BCA Protein Assay Kit



Pierce Micro BCA Protein Assay Kit is a special three-component version of the popular Pierce BCA Protein Assay Kit that is optimized to measure total protein concentration of dilute protein solutions (0.5–20 µg/mL). The easy-to-use assay (Figure 12) is exceptionally linear and exhibits very low levels of protein-to-protein variation.

Highlights:

- **Sensitive**—accurately detects down to 0.5 µg/mL (2 µg/mL in microplate format)
- **Broad linearity**—linear working range for BSA equals 0.5–20 µg/mL
- **Colorimetric**—measure with a standard spectrophotometer or plate reader (562 nm)
- **Compatible**—assay is unaffected by typical concentrations of most ionic and nonionic detergents
- **Convenient**—microplate and cuvette protocols provided with instructions

Related references

Smith PK et al. (1985) Measurement of protein using bicinchoninic acid. *Anal Biochem* 150(1):76–85.

Kang DE et al. (2002) Presenilin couples the paired phosphorylation of beta-catenin independent of axin: implications for beta-catenin activation in tumorigenesis. *Cell* 110:751–762.

Rawadi G et al. (1999) Signal transduction pathways involved in the activation of NF-kappa B, AP-1, and c-fos by Mycoplasma fermentans membrane lipoproteins in macrophages. *J Immunol* 162:2193–2203.

Blum D et al. (2002) The adenosine A1 receptor agonist adenosine amine congener exerts a neuroprotective effect against the development of striatal lesions and motor impairments in the 3-nitropropionic acid model of neurotoxicity. *J Neurosci* 22:9122–9133.

Paratcha G et al. (2003) The neural cell adhesion molecule NCAM is an alternative signaling receptor for GDNF family ligands. *Cell* 113:867–879.

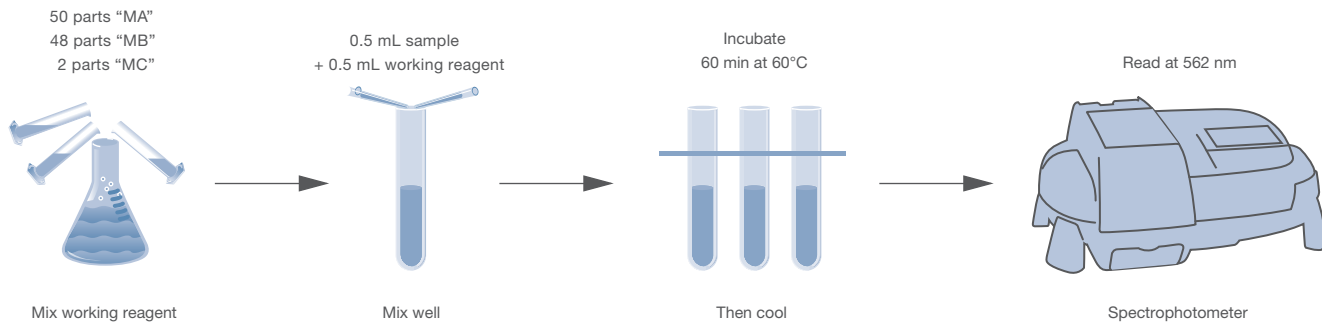

Figure 12. Pierce Micro BCA protein assay protocol.

Modified Lowry protein assay

In 1951, Oliver H. Lowry introduced this colorimetric total protein assay method [1]. It offered a significant improvement over previous protein assays, and his paper became one of the most cited references in the life science literature. The Pierce Modified Lowry protein assay represents an improvement on the original design described by Dr. Lowry by replacing two of the assay's unstable reagents with a single, more stable one. Additionally, the Pierce Modified Lowry protein assay is easier to perform than a traditional Lowry assay and offers sensitivity levels in the low mg/mL range. Structurally, the Pierce Modified Lowry protein assay is an enhanced biuret assay involving copper-chelation chemistry.

Chemistry of the Pierce Modified Lowry Protein Assay Kit

Although the mechanism of color formation for the Pierce Modified Lowry protein assay is similar to that of the Pierce BCA protein assay, there are several significant differences between the two. While the precise mechanism for color formation using the Pierce Modified Lowry protein assay is not completely understood, it is known that the reaction occurs as two distinct steps. First, protein reacts with alkaline cupric sulfate in the presence of tartrate during a 10-minute incubation at room temperature (Figure 13). During this incubation, a tetradentate copper complex forms from four peptide bonds and one atom of copper, which is light blue in color (this is the "biuret reaction").

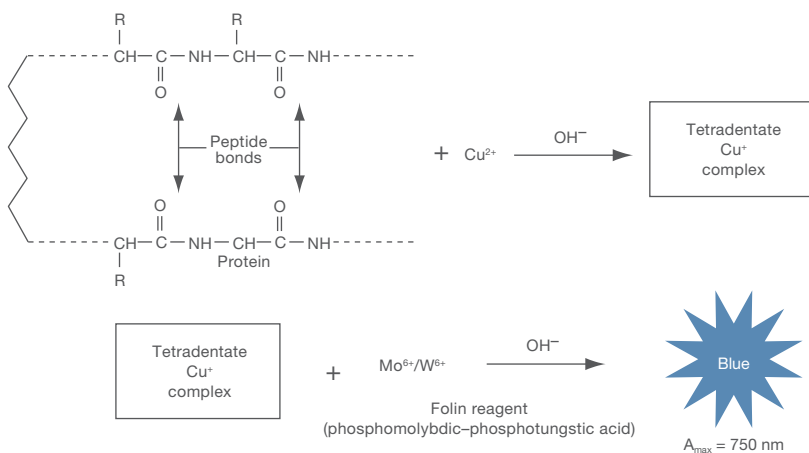

Following the incubation, the Folin phenol reagent is added. It is believed that the color enhancement occurs when the tetradentate copper complex transfers electrons to the phosphomolybdic-phosphotungstic acid complex (the Folin phenol reagent). The reduced phosphomolybdic-phosphotungstic acid complex produced by this reaction is intensely blue in color. The Folin phenol reagent loses its reactivity almost immediately upon addition to the alkaline working reagent and sample solution. The blue color continues to intensify during a 30-minute room-temperature incubation. It has been suggested by Lowry et al. [1] and Legler et al. [2] that during the 30-minute incubation, a rearrangement of the initial unstable blue complex leads to the stable final blue-colored complex that has higher absorbance.

For small peptides, the amount of color increases with the size of the peptide. The presence of any of five amino acid residues—tyrosine, tryptophan, cysteine, histidine, and asparagine—in the peptide or protein backbone further enhances the amount of color produced because these amino acids reduce the phosphomolybdic-phosphotungstic acid complex. With the exception of tyrosine and tryptophan, free amino acids will not produce a colored product with the Pierce Modified Lowry Protein Assay Reagent; however, most dipeptides can be detected. If no tyrosine, tryptophan, cysteine, histidine, or asparagine are present in the peptide backbone, then proteins containing proline residues produce a lower color response with the Pierce Modified Lowry Protein Assay Reagent due to the amino acid interfering with complex formation.

Figure 13. Reaction schematic for the Pierce Modified Lowry Protein Assay Kit.

Advantages of the Pierce Modified Lowry protein assay

The primary advantage of the Pierce Modified Lowry protein assay is flexibility in the choice of the measured absorbance wavelength. The final blue color is optimally measured at 750 nm, but it can be measured at any wavelength between 650 nm and 750 nm with little loss of color intensity. However, it is best to measure the color at 750 nm because few other substances absorb light at that wavelength. The amount of light absorbed at 750 nm is directly proportional to the amount of protein in the sample, but it's important to note that the color response curve produced is nonlinear. An additional advantage of the Pierce Modified Lowry assay is that it has a broad working range that extends from 5 to 2,000 mg/mL.

The Pierce Modified Lowry protein assay also demonstrates less protein-to-protein variation than Coomassie-based assays. Less than 15% variation is observed between the standard response curves generated using BSA and BGG (Figure 14). The Pierce Coomassie protein assay demonstrates >30% variation in the signal generated between BSA and BGG (Table 6, page 13).

Disadvantages of the Pierce Modified Lowry protein assay

The Pierce Modified Lowry protein assay will form precipitates in the presence of detergents or potassium ions. The problem of precipitation caused by the presence of potassium ions in the sample can sometimes be overcome by centrifuging the tube and measuring the color in the supernatant. Most surfactants will cause precipitation of the reagent even at very low concentrations. One exception is sodium dodecyl sulfate (SDS), which is compatible with the reagent at concentrations up to 1% in the sample.

Other substances can interfere with the color reaction. For example, chelating agents interfere with the assay by binding copper and preventing formation of the copper-peptide complex. Reducing agents and free thiols also interfere by reducing the phosphomolybdic-phosphotungstic complex, which then immediately forms an intensely blue-colored product upon their addition to the Pierce Modified Lowry Protein Assay Reagent.

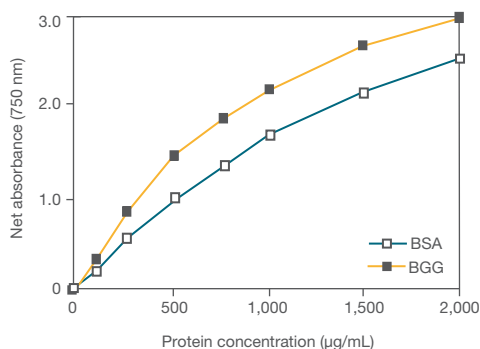

Figure 14. Color response curves obtained with the Pierce Modified Lowry Protein Assay Reagent using BSA and BGG. The standard tube protocol was performed, and the color was measured at 750 nm.

General characteristics of the Pierce Modified Lowry protein assay

The Pierce Modified Lowry Protein Assay Reagent must be refrigerated for long-term storage. If the entire bottle of reagent will be used within one month, it may be stored at room temperature (18–26°C). Reagent that has been left at room temperature for more than one month may produce a lower color response, especially at the higher end of the working range. If the reagent has been stored refrigerated, it must be warmed to room temperature before use because cold reagent will result in low absorbance values.

The protocol requires that the Folin phenol reagent be added to each tube precisely at the end of the 10-minute incubation. At the alkaline pH of the Lowry reagent, the Folin phenol reagent is almost immediately inactivated. Therefore, it is best to add the Folin phenol reagent at the precise time while simultaneously mixing each tube. Because this is somewhat cumbersome, some practice is required to obtain consistent results. This also limits the total number of samples that can be assayed in single run. If a 10-second interval between tubes is used, the maximum number of tubes that can be assayed within 10 minutes is 60 (10 seconds/tube x 60 tubes = 600 seconds or 10 minutes).

References

1. Lowry OH et al. (1951) Protein measurement with the Folin phenol reagent. *J Biol Chem* 193:265–275.
2. Legler G et al. (1985) On the chemical basis of the Lowry protein determination. *Anal Biochem* 150:278–287.

Pierce Modified Lowry Protein Assay Reagent and Kit



Highlights:

- **Colorimetric**—measure with a standard spectrophotometer or plate reader (750 nm)
- **Stable**—uses a modified, ready-to-use cupric sulfate–tartrate reagent that is stable at room temperature
- **Broad range**—exhibits good linearity in the range of 1–1,500 µg/mL (tested with BSA) with less protein-to-protein variation compared to dye-binding methods
- **Convenient**—microplate and cuvette protocols are provided in the instructions

The Pierce Modified Lowry Protein Assay Kit combines a stabilized formulation of the original Lowry reagents and the essential Folin-Ciocalteu phenol reagent in a complete kit for accurately determining protein concentration in a variety of samples types. Although newer protein assay methods provide greater speed and convenience, the Lowry method, one of the most widely cited colorimetric methods, remains a popular, accurate, and useful option for many applications.

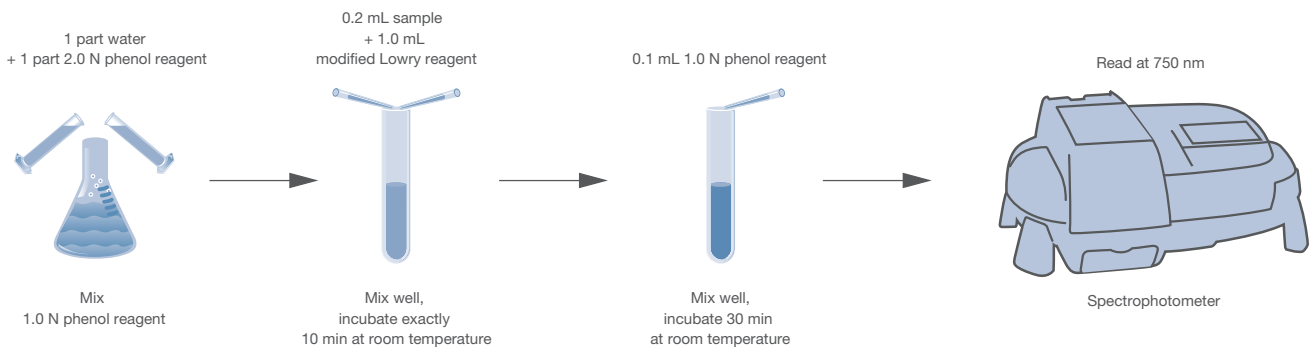

Figure 15. Pierce Modified Lowry Protein Assay Reagent protocol.

Dye-based total protein assays

The use of Coomassie G-250 dye has been a popular method for the quantitation of total protein since the 1970s. Sometimes called the “Bradford assay” because the dye’s use was first reported by Dr. Marion Bradford [1], the method is easy to use. In 2008, another dye-based assay was introduced, the Pierce 660 nm Protein Assay Kit, which overcomes some of the drawbacks of the original Coomassie total protein assay.



Coomassie dye–based protein assays (Bradford assays)

Use of Coomassie G-250 dye as a colorimetric reagent for the detection and quantitation of total protein was first described by Dr. Marion Bradford in 1976 [1]. The Pierce Coomassie (Bradford) Protein Assay Kit, the Pierce Coomassie Plus (Bradford) Assay Kit, and the Pierce Detergent Compatible Bradford Assay Kit use the reagent first reported by Dr. Bradford and other modified versions of this component for colorimetric-based protein detection.

Chemistry of Coomassie-based protein assays

In the acidic environment of the reagent, protein binds to the Coomassie dye. This results in a spectral shift from the reddish brown form of the dye (absorbance maximum at 465 nm) to the blue form (absorbance maximum at 610 nm) (Figure 16). The difference between the two dye forms is greatest at 595 nm, making it the optimal wavelength to measure the blue color from the Coomassie dye–protein complex. If desired, the blue color can be measured at any wavelength between 575 nm and 615 nm. At the two extremes (575 nm and 615 nm), there is an approximate 10% decrease in the measured amount of color (absorbance) compared to that obtained at 595 nm.

Development of color in Coomassie dye–based protein assays has been associated with the presence of certain basic amino acids—primarily arginine, lysine, and histidine—in the protein. Van der Waals forces and hydrophobic interactions also influence dye–protein binding. The number of Coomassie dye molecules bound to each protein is approximately proportional to the number of positive charges found on the protein. Free amino acids, peptides, and low molecular weight proteins do not produce color with Coomassie dye reagents. In general, the mass of a peptide or protein should be at least 3,000 Da for quantification with this reagent. In some applications, this can be an advantage.

Advantages of Coomassie dye–based protein assays

Coomassie dye–binding assays are considered the fastest and easiest to perform of all protein assays. The assay is performed at room temperature and no special equipment is required. Briefly, for either the Pierce Coomassie (Bradford) protein assay, the Pierce Coomassie Plus assay, or the Pierce Detergent Compatible Bradford assay, the sample is added to the tube containing reagent and the resultant blue color is measured at 595 nm following a short room-temperature incubation. The Coomassie dye–containing protein assays are compatible with most salts, solvents, buffers, thiols, reducing substances, and metal-chelating agents encountered in protein samples. With newer proprietary additives, the Coomassie reagent can also be compatible with many commonly used detergents.

Disadvantages of Coomassie dye–based protein assays

The main disadvantage of some Coomassie dye–based protein assays is their incompatibility with surfactants at concentrations routinely used to solubilize membrane proteins. In general, the presence of a surfactant in the sample, even at low concentrations, causes precipitation of the reagent. If surfactants are an issue, consider newer formulations of the reagent (e.g., Pierce Detergent Compatible Bradford Assay Kit) that can overcome these issues.

Another problem concerns the acidity of the Coomassie dye reagent. The highly acidic dye cannot assay a small number of proteins due to their poor solubility in the reagent. Also, Coomassie reagents result in about twice as much protein–protein variation as copper chelation–based assay reagents (Table 6, page 13) and generally produce standard curves that are less linear than those of BCA assays. This can make comparison of highly variable samples—both in protein composition and concentration—difficult. Finally, Coomassie dye stains the glass or quartz cuvettes used with spectrophotometers. Cuvettes can be cleaned with strong detergent solutions and/or methanol washes, but use of disposable polystyrene cuvettes eliminates the need to clean cuvettes.

General characteristics of Coomassie dye–based protein assays

Coomassie dye–based protein assays share a number of characteristics. Coomassie dye–based protein assays must be refrigerated for long-term storage. If ready-to-use liquid Coomassie dye reagents will be used within one month, they may be stored at ambient temperature (18–26°C). Coomassie protein assay reagent that has been left at room temperature for several months will have a lower color response, especially at the high end of the working range. Coomassie protein assay reagents that have been stored refrigerated must be warmed to room temperature before use. The use of either cold plates or cold liquid Coomassie dye reagent will result in low absorbance values.

The dye in the ready-to-use liquid Coomassie dye reagents spontaneously forms loose aggregates upon standing, which may become visible after the reagent has been standing for as little as 60 minutes. Prior to use, gentle mixing of these reagents by inversion of the bottle will uniformly disperse the dye. After binding to protein, the dye also forms protein–dye aggregates. Fortunately, these protein–dye aggregates can be dispersed easily by mixing the reaction tube. This is common to all liquid Coomassie dye reagents. Since these aggregates form relatively quickly, it is also best to routinely vortex each tube or plate for 2–3 seconds just before measuring the color.

Reference

- Bradford M (1976) A rapid and sensitive method for the quantitation of microgram quantities of protein utilizing the principle of protein-dye binding. *Anal Biochem* 72:248–254.

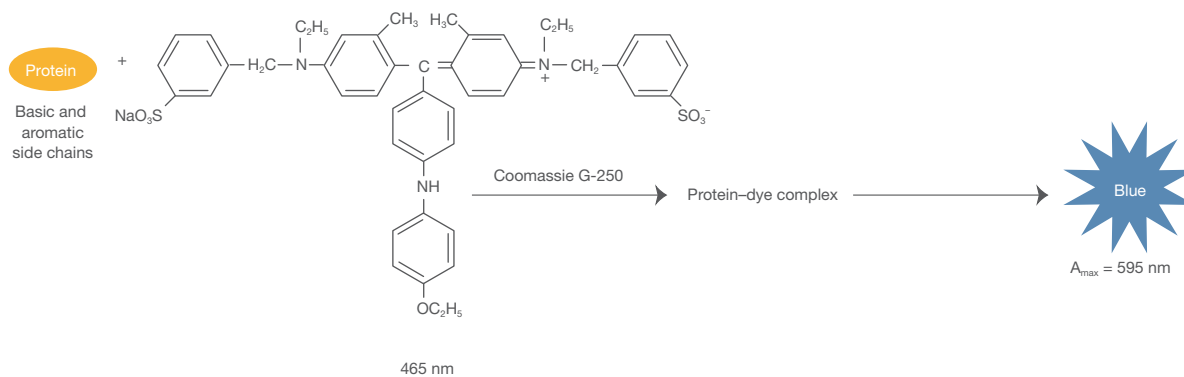

Figure 16. Reaction schematic for the Coomassie dye–based protein assays: Pierce Coomassie (Bradford) protein assay, the Pierce Coomassie Plus (Bradford) assay, and Pierce Detergent Compatible Bradford assay.

Pierce Detergent Compatible Bradford Assay Kit



Pierce Detergent Compatible Bradford Assay Kit is a quick and ready-to-use modification of the well-known Bradford Coomassie-binding colorimetric method for total protein quantitation and offers advantages over other commercially available products (Table 11, Figures 17 and 18). Proprietary additives to the Bradford reagent found in the Pierce Detergent Compatible Bradford Assay Kit make it compatible with 1% or higher of 11 detergents and lysis reagents that are commonly used in life scientific research, including Triton X-100 and NP-40 detergents. Similar to the Bradford method, Coomassie dye binds to proteins in an acidic medium, causing an immediate shift in absorption maximum from 465 nm to 595 nm with a concomitant color change from green to blue. The assay is complete in just 10 minutes.

Highlights:

- **Flexible**—compatible with both detergent-free samples and detergent-containing samples
- **Convenient**—detergent-free standard curve; use standards directly without preparation in the same detergent found in the test samples
- **Minimal sample**—requires only 10 μL for microplate procedure
- **Easy to use**—single reagent; no working reagent preparation required
- **Fast**—10-minute incubation at room temperature
- **Broad range**—detects protein in the range of 2–1,500 $\mu\text{g}/\text{mL}$

Table 11. The Pierce Detergent Compatible Bradford Assay Kit provides advantages over the Bio-Rad™ DC™ Protein Assay.

Feature	Pierce Detergent Compatible Bradford Assay Kit	Bio-Rad DC Protein Assay Kit
Assay measurement (absorbance maximum)	595 nm	750 nm
Detergent-free standards	Yes	No
Test tube assay sample volume	50 μL	100 μL
Microplate assay sample volume	10 μL	5 μL
Assay working range	100–1,500 $\mu\text{g}/\text{mL}$	200–1,500 $\mu\text{g}/\text{mL}$
Absorbance range (sensitivity)	High*	Low
Number of reagents in kit	1 reagent	3 reagents
Setup time	10 min	30 min
Incubation time	10 min	15 min
Total time	20 min	45 min

* The Pierce Detergent Compatible Bradford protein assay's absorbance reading range is 4 times broader than the range for the DC protein assay.

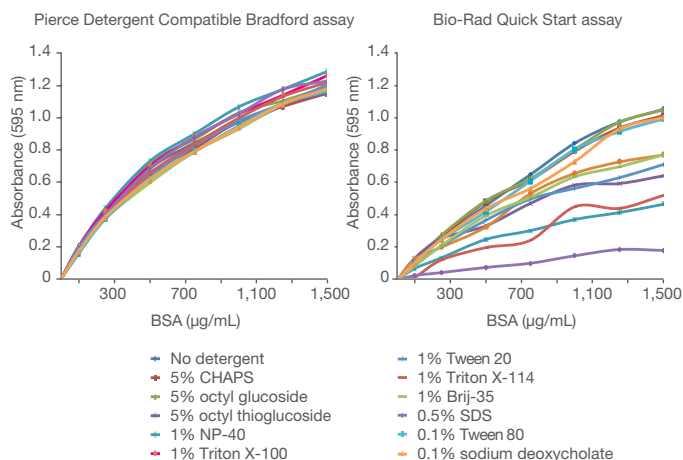

Figure 17. Excellent detergent compatibility with the Pierce Detergent Compatible Bradford protein assay Kit vs. the Bio-Rad™ Quick Start™ Bradford Protein Assay. Assays were performed according to the microplate procedure using BSA standards spiked with detergent or water (control). Sample and reagent volumes used were according to the manufacturer's instructions. Each assay was incubated for 10 minutes and absorbance was measured at 595 nm. The Pierce Detergent Compatible Bradford assay is compatible with 11 commonly used detergents. Compatibility is defined as $\leq 10\%$ difference in absorbance between samples with and without detergent. In contrast, the Bio-Rad Quick Start Bradford Protein Assay is compatible with only three of the 11 detergents tested.

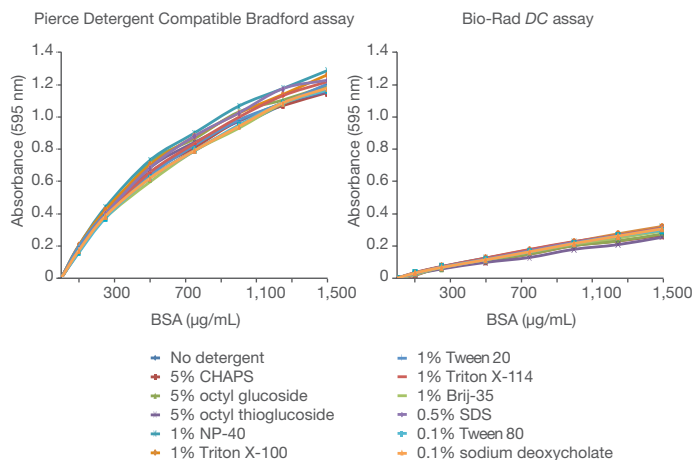

Figure 18. Better sensitivity with the Pierce Detergent Compatible Bradford protein assay vs. the Bio-Rad DC protein assay. Each assay was performed in a microplate using BSA standards spiked with detergent or water (control), and followed the manufacturers' instructions. The range of the standard curve for the Pierce Detergent Compatible Bradford assay is 4 times broader than the range for the Bio-Rad DC assay.

Pierce Coomassie Plus (Bradford) Protein Assay Kit and Reagent



The Pierce Coomassie Plus (Bradford) Protein Assay Kit provides a ready-to-use, reducing agent-compatible Bradford assay reagent to quickly measure total protein concentration compared to a protein standard. Simply add the reagent to samples and standards, mix, and then measure the absorbance at 595 nm (Figure 19). The assay costs only pennies per sample and can be performed in either test tube or microplate format. The Pierce Coomassie Plus Protein Assay Reagent provides increased linearity of response (Figure 20) and only half the protein-to-protein variation of other commercial Bradford assay formulations.

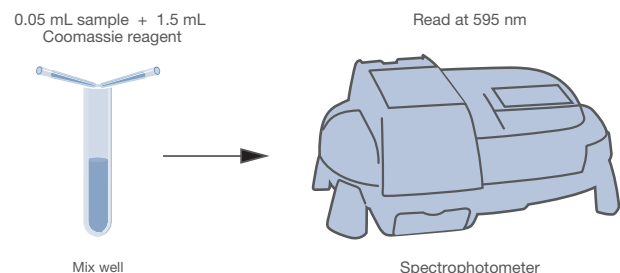

Figure 19. Pierce Coomassie Plus (Bradford) assay protocol.

The protocol is simple, fast, and very easy to perform.

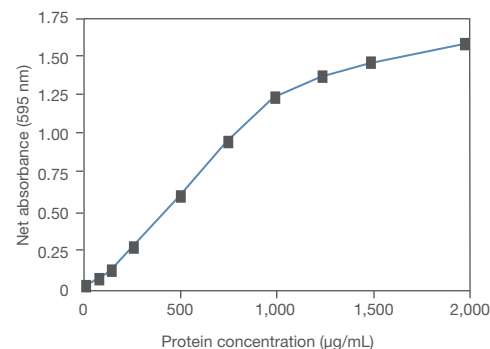

Figure 20. Typical color response curve for BSA using the Pierce Coomassie Plus (Bradford) Protein Assay Reagent.

Highlights:

- **Colorimetric**—measure with a standard spectrophotometer or plate reader (595 nm)
- **Easy to use**—single reagent assay requires no working reagent preparation
- **Fast**—perform assay in less than 10 minutes with almost immediate color development
- **Broad detection range**—detects protein concentration in the range of 1–1,500 µg/mL
- **Better accuracy**—offers improved linearity and response uniformity compared to traditional Bradford formulations
- **Flexible**—microplate and cuvette protocols are adaptable to several target working ranges

Related references

Bradford M (1976) A rapid and sensitive method for the quantitation of microgram quantities of protein utilizing the principle of protein-dye binding. *Anal Biochem* 72:248–254.

Glover BP, McHenry CS (2001) The DNA polymerase III holoenzyme: an asymmetric dimeric replicative complex with leading and lagging strand polymerases. *Cell* 105:925–934.

Kagan A et al. (2000) The dominant negative LQT2 mutation A561V reduces wild-type HERG expression. *J Biol Chem* 275:11241–11248.

Goel R et al. (2002) alpha-Thrombin induces rapid and sustained Akt phosphorylation by beta-arrestin1-dependent and -independent mechanisms, and only the sustained Akt phosphorylation is essential for G1 phase progression. *J Biol Chem* 277:18640–18648.

Pierce Coomassie (Bradford) Protein Assay Kit



The Pierce Coomassie (Bradford) Protein Assay Kit is a ready-to-use formulation of the popular assay reagent originally described by Bradford in 1976. When mixed with a protein solution, the acidic Coomassie dye reagent changes color from brown to blue in proportion to the amount of protein present in the sample. Protein determinations are made by comparison to the color response of protein assay standards. This ready-to-use formulation closely resembles in performance the reagent published by Bradford [1]. It demonstrates the typical assay characteristics known for Coomassie dye-based formulations [2].

The kit includes Coomassie Protein Assay Reagent and a package of albumin standard ampules. The simple procedure is adaptable to nearly any volume scale, including test tubes, cuvettes, and microplates.

Highlights:

- **Convenient**—stable, ready-to-use kit of the classical Bradford assay reagent
- **Colorimetric**—measure with a standard spectrophotometer or plate reader (595 nm)
- **Fast**—add, mix, and read results with almost immediate color development
- **Broad detection range**—detects protein concentration in the range of 1–1,500 $\mu\text{g/mL}$
- **Flexible**—microplate and cuvette protocols are adaptable to several target working ranges

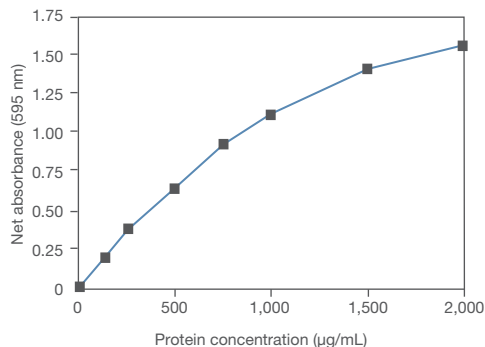

Figure 21. Pierce Coomassie (Bradford) Protein Assay Reagent: typical color response curve for BSA.

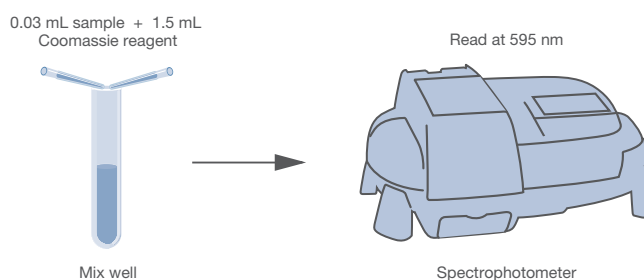

Figure 22. Pierce Coomassie (Bradford) protein assay protocol.

References

1. Bradford M (1976) A rapid and sensitive method for the quantitation of microgram quantities of protein utilizing the principle of protein-dye binding. *Anal Biochem* 72:248–254.
2. van Kley H, Hale SM (1977) Assay for protein by dye binding. *Anal Biochem* 81:485–487.

Other dye-based assays: Pierce 660 nm protein assay

Accurate protein concentration measurements are required to study many biochemical processes. While the Bradford assay is the most commonly used dye-binding protein assay, it is prone to inaccuracy from its typical nonlinear standard curves. Moreover, some forms of the assay are not compatible with samples containing detergents at commonly used concentrations. The Pierce 660 nm protein assay uses dye-based reagent that offers the same convenience as Coomassie dye-based assays while overcoming several of their disadvantages. In particular, the Pierce 660 nm protein assay is compatible with most detergents and produces a more linear response curve.

While the detailed chemistry is proprietary, it can be summarized as follows: a proprietary dye-metal complex in an acidic buffer binds to protein in the acidic condition, causing a shift in the dye's absorption maximum, which is measured at 660 nm. The reagent is reddish-brown and changes to green upon protein binding. The color produced in the assay is stable and increases in proportion to a broad range of increasing protein concentrations. The color change is produced by deprotonation of the dye at low pH, facilitated by protein-binding interactions between positively charged amino acid groups and the negatively charged deprotonated dye-metal complex.

The assay binds to proteins in a manner similar to Coomassie dye. Thus, it has similar protein-to-protein variation to Coomassie (Bradford) assay methods. However, unlike Coomassie dye-based assays, the Pierce 660 nm protein assay is fully compatible with nonionic detergents typically used in protein samples. In fact, when used with the Ionic Detergent Compatibility Reagent (IDCR), the Pierce 660 nm assay is also compatible with sample containing Laemmli SDS sample buffer with bromophenol blue and other buffers containing common ionic detergents.

Pierce 660 nm protein assays



The Pierce 660 nm Protein Assay Reagent provides a ready-to-use, detergent- and reducing agent-compatible assay reagent to quickly measure total protein concentration compared to a protein standard. The Pierce 660 nm protein assay is based on the binding of a proprietary dye-metal complex to protein in acidic conditions that causes a shift in the dye's absorption maximum, which is measured at 660 nm. The assay is more linear than Coomassie dye-based Bradford assays and is compatible with higher concentrations of most detergents, reducing agents, and other commonly used reagents. The accessory IDCR provides for even broader detergent compatibility, making this one of the only protein assays that is suitable for samples containing Laemmli SDS sample buffer with bromophenol blue.

Although the Pierce 660 nm Protein Assay Reagent produces a higher level of protein-to-protein variation (37%) than other assays such as the Pierce BCA protein assay, the simpler single-reagent format and broader substance compatibility make the Pierce 660 nm Protein Assay Reagent more convenient for many routine applications. The Pierce 660 nm protein assay can be performed in either a test tube or microplate format.

Highlights:

- **Improved accuracy**—produces standard curves that are more linear than the Bradford method
- **Fast**—uses single reagent with a simple mix-and-read assay
- **Economical**—uses small volumes of valuable samples: 10 μL in microplate and 100 μL in standard procedures
- **Convenient**—room-temperature storage means no waiting for the reagent to warm up before use
- **Broader compatibility**—works with a greater range of detergents and reducing agents than other dye-based assays
- **Broad detection range**—detects protein concentration in the range of 25–2,000 $\mu\text{g}/\text{mL}$ for the test tube assay and 50–2,000 $\mu\text{g}/\text{mL}$ for the microplate assay (Figures 24 and 25)

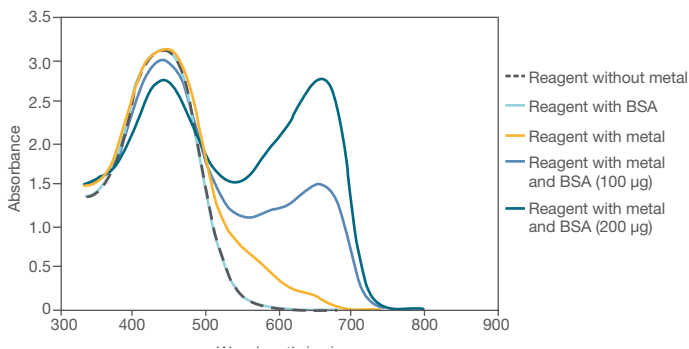

Figure 23. The absorption maximum of the reagent–metal complex shifts proportionally upon binding to BSA. The absorption spectra were recorded for the Pierce 660 nm Protein Assay Reagent from 340 to 800 nm using a Varian Cary™ Spectrophotometer. The assay reagent is a proprietary dye–metal complex that binds to protein in acidic conditions, which shifts the dye’s absorption maximum.

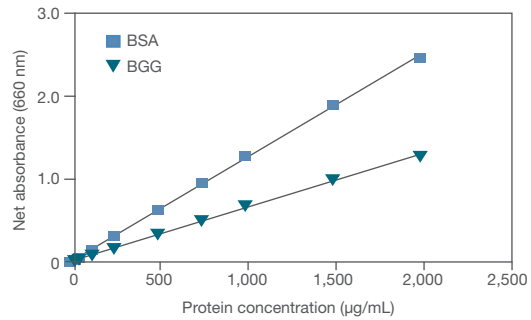

Figure 24. Typical color response curves for the test tube procedure of the Pierce 660 nm Protein Assay Reagent. The linear detection ranges are 25–2,000 $\mu\text{g}/\text{mL}$ for BSA and 50–2,000 $\mu\text{g}/\text{mL}$ for BGG. The average absorbance for the blank replicates (control) was subtracted from the absorbance for individual standard replicates.

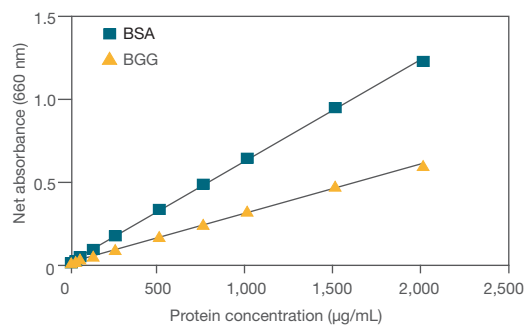

Figure 25. Typical color response curves for the microplate procedure. The linear detection range is 50–2,000 $\mu\text{g}/\text{mL}$ for BSA and BGG. The average absorbance for the blank replicates (control) was subtracted from the absorbance for individual standard replicates.

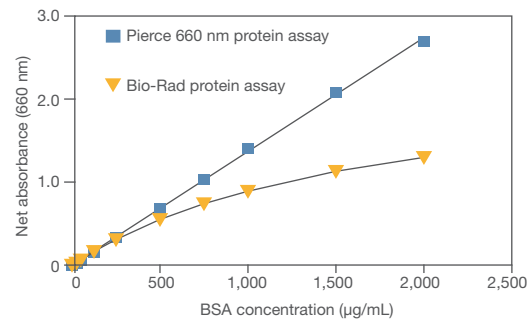

Figure 26. Performance comparison of Bradford protein assay vs. the Pierce 660 nm protein assay. Assays were performed according to the standard test tube procedure using 100 μL of BSA. The Pierce 660 nm protein assay has a greater linear range of 25–2,000 $\mu\text{g}/\text{mL}$, compared with the Bradford assay, which has a linear range of only 125–1,000 $\mu\text{g}/\text{mL}$.

Specialty assays

In some instances, more specialized assays are required to quantify peptides, antibodies, protein modifications, or functional (enzymatic) classes of proteins.



Other protein assays

Compat-Able Protein Assay Preparation Reagent Kit



Highlights:

- **Improved protein purification**—removes nearly any substance that interferes with colorimetric protein assays: salts, detergents, denaturants, reducing agents, and isoelectric focussing (IEF) sample buffer
- **Simple and fast**—prepare samples in less than 10 minutes with four simple steps (Figure 27)
- **Convenient**—reagent set is easier to use than homemade TCA or acetone precipitation reagents
- **Scalable**—microcentrifuge method is easily scaled to larger centrifuge tube volumes for special needs
- **Validated**—tested and offered together with Pierce BCA and Coomassie Plus Protein Assay Kits

Compat-Able Protein Assay Preparation Reagent Kit removes salts, detergents, reducing agents, and other substances from protein samples to eliminate interference with BCA and Bradford protein assays. The protocol selectively precipitates all of the protein, allowing the interfering substances to be easily decanted, without dialysis or gel filtration. The purified, precipitated protein is then dissolved in water, making it ready for accurate determination of the protein concentration by the Pierce BCA Protein Assays or the Pierce Coomassie Plus Protein Assay Kit (available with Compat-Able reagents and separately).

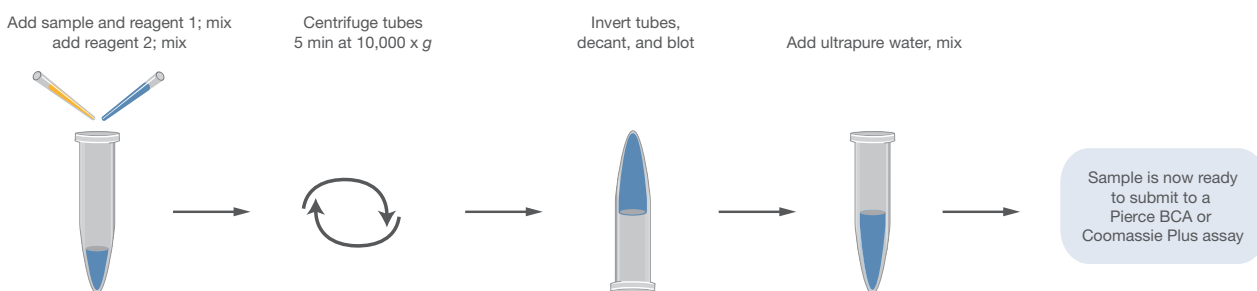

Figure 27. Compat-Able protein assay protocol. Make almost any protein sample compatible with the Pierce BCA or Coomassie Plus (Bradford) assays in four simple steps.

Peptides

Pierce Quantitative Colorimetric Peptide Assay



The Pierce Quantitative Colorimetric Peptide Assay is a modified BCA assay with a proprietary chelator optimized for the quantitation of peptide mixtures. In this reaction, the copper is first reduced by the amide backbone of peptides under alkaline conditions (biuret reaction), followed by the proprietary chelator coupling with the reduced copper to form a bright red complex with absorbance at 480 nm. The signal produced from this reaction is 3 to 4-fold more sensitive than the Pierce Micro BCA protein assay for peptide analysis (Figure 28). This colorimetric peptide assay requires a small amount (20 μ L) of sample with a working peptide concentration range of 25–1,000 μ g/mL and is best suited for peptide mixtures and complex digests (labeled and unlabeled). The kit also contains a high-quality peptide digest reference standard for use in generating linear standard curves and to serve as a calibration control.

Highlights:

- **Sensitive**—accurately detect as little as 25 μ g/mL of peptide mixture
- **Reliable**—assay performance is rigorously tested using peptide digest mixtures
- **Complete**—kit includes a validated peptide digest standard for improved reproducibility of quantitation
- **Compatible**—works with many reagents, including mass spectrometry sample preparation reagents (see Table 12) and Thermo Scientific™ Tandem Mass Tag™ (TMT™) labeled peptides

- **Convenient**—read absorbance levels in as little as 15 minutes using an easy mix-and-read format with stable colorimetric signal

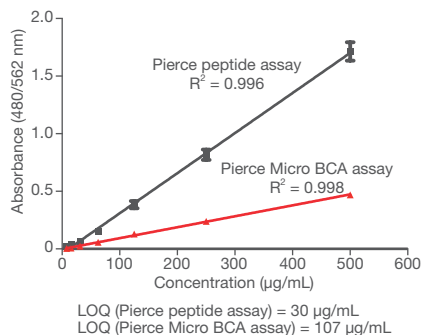

Figure 28. Sensitivity of Pierce Quantitative Colorimetric Peptide Assay. A BSA tryptic digest was serially diluted from 500 μ g/mL to 15 μ g/mL to compare assay sensitivities. Each sample was assayed in triplicate and error bars represent standard deviation. Limit of quantitation (LOQ) for the assay was determined by the following equation: $LOQ = 10 \times$ (standard deviation of blank + average of blank).

Table 12. Compatible substance concentrations for the Pierce Quantitative Colorimetric Peptide Assay.

Substance	Compatible concentration
Acetone	50%
Acetonitrile	50%
Ammonium bicarbonate	50 mM
DMSO	50%
DTT	Not compatible
EDTA	5 mM
Formic acid	0.5%
Guanidine	0.25 M
Iodoacetamide	1 M
Methanol	25%
SDS	1%
Sodium azide	1%
TCEP	Not compatible
TEA acetate	5 mM
TEA bicarbonate	5 mM
Trifluoroacetic acid	0.5%
Tris	100 mM
Urea	1 M

Note: It is possible to have a substance additive effect even though a single component may be present at a concentration below its listed compatibility. A sample buffer containing a combination of substances could potentially interfere with the assay. Combinations of reagents have not been examined in detail.

Pierce Quantitative Fluorometric Peptide Assay



The Pierce Quantitative Fluorometric Peptide Assay kit is designed for the sensitive quantitative measurement of peptide concentrations. In this assay, peptides are specifically labeled at the amino terminus using an amine-reactive fluorescent reagent, and the fluorescently labeled peptides are detected using excitation/emission maxima of 390/475 nm. This sensitive assay only requires 10 μ L of sample, produces a linear response with increasing peptide concentrations (5–1,000 μ g/mL) (Figure 29), results in a stable final fluorescence that can be detected in as few as 5 minutes, and is suitable for the quantitative measurement of synthetic peptides as well as peptide digest mixtures. A high-quality peptide digest reference standard is included for use in generating linear standard curves and as a calibration control enabling improved accuracy and reproducibility.

Highlights:

- **Sensitive**—accurately detect as little as 5 μ g/mL of single peptides or peptide mixtures
- **Robust**— assay performance is rigorously tested using both peptides and peptide digest mixtures
- **Complete**—kit includes a validated peptide digest standard for improved reproducibility of quantitation
- **Compatible**—works with many reagents, including those used in mass spectrometry sample preparation (Table 13)
- **Convenient**—using an easy mix-and-read format with stable fluorescence signal, measure fluorescence in as little as 5 minutes and up to several hours

Table 13. Compatible substance concentrations for the Pierce Quantitative Fluorometric Peptide Assay.

Substance	Compatible concentration
Acetone	25%
Acetonitrile	50%
Ammonium acetate	100 mM
Ammonium bicarbonate	50 mM
DMSO	50%
DTT (dithiothreitol)	10 mM
EDTA	25 mM
Formic acid	0.1%
Guanidine	1 M
Iodoacetamide	100 mM
Methanol	25%
SDS	1%
Sodium azide	1%
TCEP	10 mM
TEA acetate	100 mM
TEA bicarbonate	100 mM
Trifluoroacetic acid	0.2%
Urea	1 M

Note: It is possible to have a substance additive effect even though a single component may be present at a concentration below its listed compatibility. A sample buffer containing a combination of substances could potentially interfere with the assay. Combinations of reagents have not been examined in detail.

Peptide Digest Assay Standard

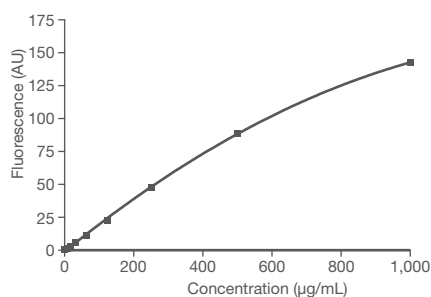

Figure 29. Standard curve for Pierce Quantitative Fluorometric Peptide Assay using the Peptide Digest Assay Standard.

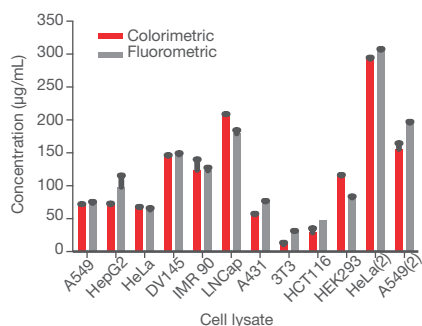

Figure 30. Quantitation comparison between colorimetric and fluorometric peptide assays. Tryptic peptide digests were prepared from 12 cell lines. Peptide digest concentrations were determined using both assay kits according to instructions. Each sample was assayed in triplicate, and the concentration of each digest was calculated with standard curve generated using the Peptide Digest Assay Standard. Note: HeLa(2) and A549(2) were a second peptide digest performed using a higher amount starting material.



Thermo Scientific™ Peptide Digest Assay Standard is a validated protein digest reference sample optimized for use in quantitative peptide assays to improve reproducibility and accuracy.

The reference protein has been digested with MS-grade trypsin to minimize missed cleavages. To help ensure consistent performance, digestion efficiency of the protein is monitored to help ensure lot-to-lot consistency, and quality is assessed by comparison to a reference standard. The Peptide Digest Assay Standard is provided in ready-to-use liquid format at 1 mg/mL and is sufficient for at least ten standard curves (depending on dilution volumes).

Highlights:

- **Distinct**—the only commercially available peptide digest standard that has been developed for use in a quantitative peptide assay
- **Validated**—tested with both the Pierce Quantitative Fluorometric Peptide Assay and the Pierce Quantitative Colorimetric Peptide Assay with comparable standard curves using both assays
- **Stable**—liquid formulation is stored at 4°C, eliminating variability due to freeze/thaw cycles
- **Easy to use**—provided in a liquid format with a known peptide concentration

Antibodies

Easy-Titer IgG and IgM assay kits



Thermo Scientific™ Easy-Titer™ assay kits detect and measure specific target antibodies using agglutination of microspheres that are coated (i.e., sensitized) with anti-IgG or anti-IgM polyclonal antibodies that can bind to the target immunoglobulin of interest. In the appropriate aqueous buffer (supplied in kit), the monodispersed antibody-coated microspheres have highest absorptivity (λ_{\max}) to incident light, with a wavelength (340 nm) that is equal to approximately half their diameter. When sample is added, two or more microspheres bind to each antibody target via their coated specific polyclonal antibodies (Figure 31), and this agglutination into larger apparent spheres results in proportional decrease in absorptivity (lower absorbance).

The Easy-Titer assay kits do not cross-react with antibodies from other species such as bovine antibodies present in the media used to culture antibody-producing hybridoma cells. This remarkable specificity allows the measurement of IgG and IgM concentrations in a variety of sample types such as culture supernatants, ascites, or body fluids without first purifying the antibody from other contaminants. The Easy-Titer antibodies are also sold separately.

Highlights:

- **Antibody-based specificity**—measure concentration of target antibody in a sample, not just total protein; no need to purify antibody to assess its concentration
- **Faster and easier than ELISA**—uses a three-component, homogeneous assay, with 10-minute total incubation time (Figure 32)
- **No special equipment needed**—uses standard vortex mixer, pipetter, 96-well microplate, plate shaker, and reader (measure absorbance at 340 nm or 405 nm)
- **Sensitive**—demonstrates an assay range of 8–500 ng/mL; use sample at 15–300 ng/mL for optimal results (Figure 33)
- **Reproducible**—displays a CV of <5%; error depends on dilution and pipetting technique

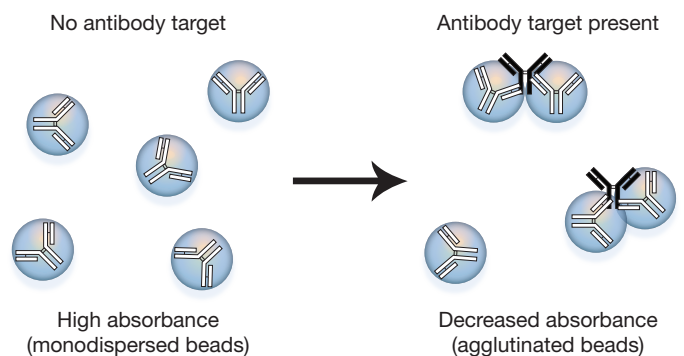

Figure 31. Microsphere agglutination assay. The Easy-Titer assay kits use antibody-sensitized microspheres to specifically assay target antibody species based on microagglutination.

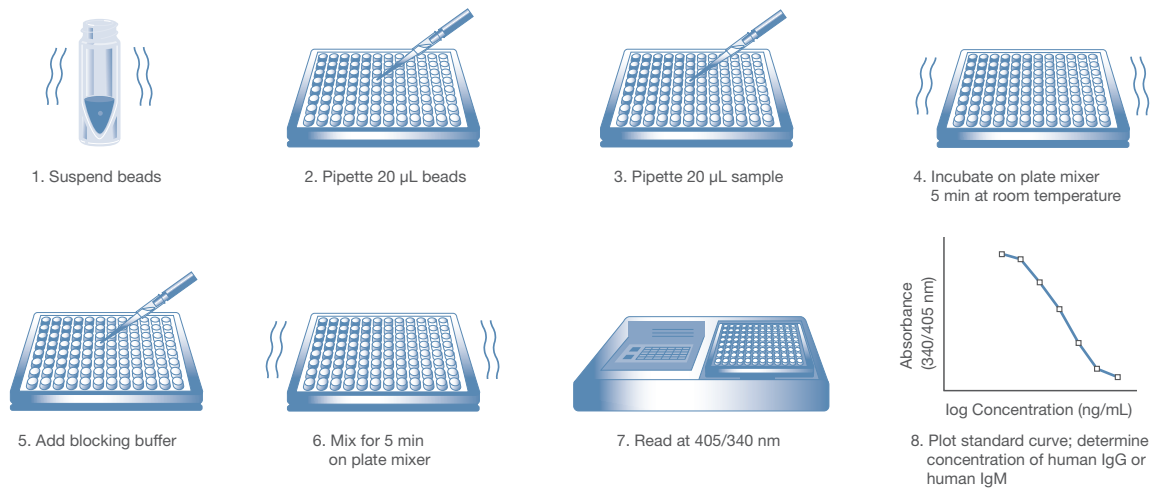

Figure 32. Easy-Titer IgG and IgM Assay Kit protocol. Easy-Titer assay kits feature a simple procedure that reduces hands-on time and requires fewer steps that lead to more reproducible results. The entire process can be completed easily in about 30 minutes.

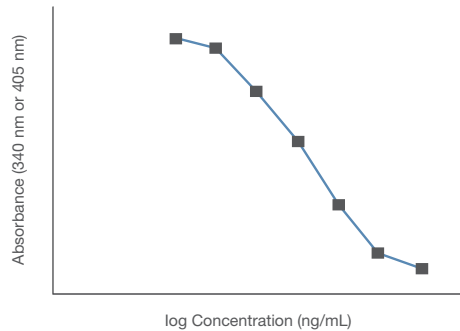

Figure 33. Typical antibody quantitation by microagglutination assay. Easy-Titer assay kit results, plotted at 340 nm or 405 nm absorbance measurements, yield negative-slope standard curves for assessment of diluted samples in the range of 8–500 ng/mL.

Related reference

Brown MA et al. (2000) Identification and purification of vitamin K-dependent proteins and peptides with monoclonal antibodies specific for gamma-carboxyglutamyl (Gla) residues. *J Biol Chem* 275:19795–19802.

Proteases

Pierce protease assay kits: colorimetric and fluorometric



The Thermo Scientific™ Pierce™ Fluorescent Protease Assay Kit includes fluorescein-labeled casein as a substrate for assessing protease activity in a sample by either fluorescence resonance energy transfer (FRET) with a standard fluorometer or fluorescence polarization (FP) with capable instrumentation. FITC-casein is native casein that has been labeled using a large molar excess of fluorescein isothiocyanate (FITC). Fluorescence properties of this heavily labeled, intact protein substrate change dramatically upon digestion by proteases, resulting in a measurable indication of proteolysis (Figure 34).

The Thermo Scientific™ Pierce™ Colorimetric Protease Assay Kit uses fully succinylated casein as a substrate for the assay. Hydrolysis of this substrate in the presence of protease results in the release of peptide fragments with free amino-terminal groups. These peptides are reacted with trinitrobenzene sulfonic acid (TNBSA), followed by measurement of the absorbance increase that results from the formation of yellow-colored TNB-peptide adducts (Figure 35).

Highlights:

- **Versatile**—measure activity of any protease that cleaves casein into peptide fragments
- **Standardized**—quantify protease activity relative to trypsin, a universally accepted reference
- **Sensitive**—perform an assay that is 1,000 times more sensitive than those that use unmodified forms of casein; detects protease concentration as low as 2 ng/mL
- **Fast**—complete test tube and microplate protocols in less than 1 hour
- **Easy-to-use**—requires addition steps only; no separation, transfer, or stop steps required
- **Customizable**—easily adapt time, temperature, and pH to optimize sensitivity for proteases of interest

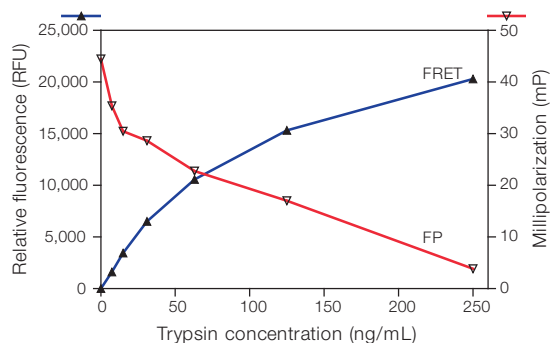

Figure 34. Pierce fluorescent protease assay standard curves in FRET and FP modes. The Pierce Fluorescent Protease Assay Kit measures relative protease activity for digestion of FITC-conjugated casein substrate by comparison to a supplied trypsin standard. The assay can be measured in either FRET or FP modes.

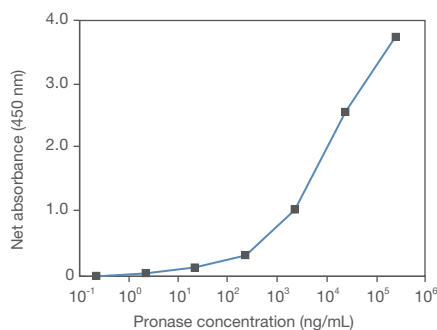

Figure 35. Sensitivity of the Pierce colorimetric protease assay.

Related reference

Rao SK et al. (1997) A versatile microassay for elastase using succinylated elastin. *Anal Biochem* 250(2):222–227.

Glycoproteins

Pierce Glycoprotein Carbohydrate Estimation Kit

The Thermo Scientific™ Pierce™ Glycoprotein Carbohydrate Estimation Kit includes six purified glycoprotein standards and the required assay reagents to effectively estimate the amount of oxidizable glycosylation (percent carbohydrate by weight) of purified protein samples. In the assay, sugar groups in the glycoprotein sample are first oxidized with sodium metaperiodate to produce detectable aldehyde groups (Figure 36). Then the sample is reacted with the colorimetric glycoprotein detection reagent. Absorbance at 550 nm of the resulting purple reaction product is measured with a spectrophotometer or plate reader. Finally, the carbohydrate content in the glycoprotein is calculated by comparison to results from the five glycoprotein standards that are included in the kit.

Highlights:

- **Qualitative**—easily identifies purified proteins as glycoproteins or samples as contaminated with sugars
- **Semi-quantitative**—estimates the percent carbohydrate content (w/w) of purified glycoprotein by comparison to the included set of glycoprotein standards
- **Easy to use**—complete protocol in less than 75 minutes; instructions include microplate and test tube protocols
- **Adaptable**—standard curve format allows for the design of alternative tests for aldehydes and carbohydrate components

1. Add 50 μL of protein standard or sample to each well.

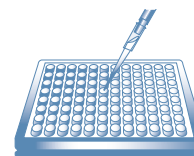

2. Add 25 μL of 10 mM sodium metaperiodate in assay buffer.

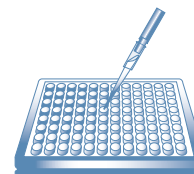

3. Mix and incubate for 10 min at room temperature.

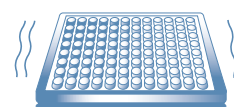

4. Add 150 μL of a 0.5% solution of Pierce Glycoprotein Detection Reagent in 1.0 M NaOH.

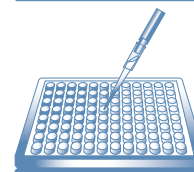

5. Mix and incubate at room temperature for 60 min.

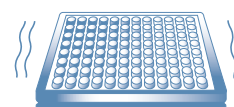

6. Read the plate in a microplate reader at 550 nm. Interpolate the results of the unknown with the results of the standard proteins.



Figure 36. The Pierce Glycoprotein Carbohydrate Estimation Assay Kit microplate protocol.

Phosphoproteins

Pierce Phosphoprotein Phosphate Estimation Kit

The Thermo Scientific™ Pierce™ Phosphoprotein Phosphate Estimation Kit is designed to aid in characterization of the status and extent of phosphorylation of purified protein samples. The assay is based on the alkaline hydrolysis of phosphate from seryl and threonyl residues in phosphoproteins and quantification of the released phosphate with malachite green and ammonium molybdate. The assay is easily performed in 96-well microplates or test tubes and is completed in about 1 hour (Figure 37).

The assay can be used to identify whether a purified protein contains either phosphoserine (pSer) or phosphothreonine (pThr) as well as to estimate the level of this type of phosphorylation. For quantitation, the test protein sample is compared with specific concentrations of phosvitin, a phosphoprotein of known phosphorylation level.*

* Note: The alkaline hydrolysis step does not release phosphate from phosphotyrosine (pTyr) residues in peptide linkages. Therefore, a negative result for an unknown purified protein preparation indicates that the protein either (1) is not a phosphoprotein or (2) is phosphorylated exclusively at tyrosine residues. In the latter case, western blot analysis using an anti-phosphotyrosine antibody will be necessary to distinguish between these two possibilities.

Highlights:

- **Specific**—measures pSer and pThr only; does not measure pTyr
- **Convenient**—includes test tube and 96-well microplate protocols and typically requires less than 90 minutes to perform
- **Semi-quantitative**—calculate moles of phosphate per mole of protein using the included phosvitin standard
- **Customizable**—adaptable to development of specific assays for pure phosphoproteins when previously characterized standards are available

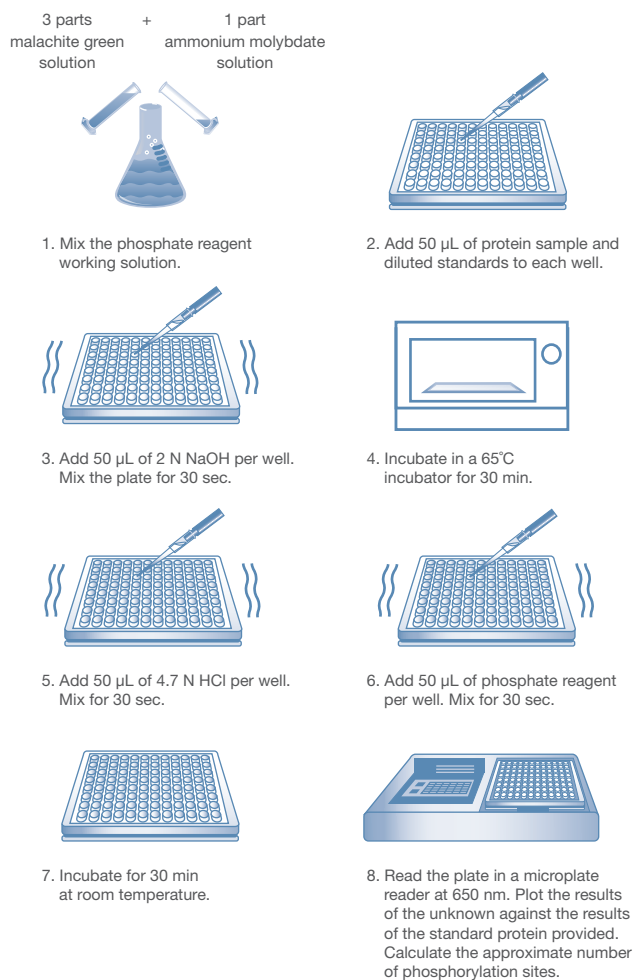

Figure 37. The Pierce Phosphoprotein Phosphate Estimation Kit microplate protocol.

Peroxides

Pierce Quantitative Peroxide Assay Kits



The Thermo Scientific™ Pierce™ Quantitative Peroxide Assay Kits are easy to use for detecting the presence of peroxides in both aqueous and lipid-containing laboratory reagents (Table 14). The basis of these assays is the complexation of ferric ion (Fe^{2+}) by H_2O_2 in the presence of xylenol orange. Peroxides in the sample oxidize Fe^{2+} to Fe^{3+} , after which Fe^{3+} forms a colored complex with xylenol orange that can be read at 560 nm. Peroxide levels in test samples can be determined by calculation from the known extinction coefficient of the xylenol orange–Fe complex or by reference to a standard curve prepared with hydrogen peroxide solution. When performed on a routine basis, the Pierce quantitative peroxide assay can help prevent inadvertent introduction of peroxides into valuable samples.

Highlights:

- **Accurate**—detects and measures hydrogen peroxide (H_2O_2) levels in biological and other liquids samples
- **Convenient**—the ready-to-use kit minimizes the variability, difficulty, and added expense of formulating the reagents yourself

Table 14. Comparison of assay protocols for lipid peroxide content.

Pierce quantitative peroxidase assay	Thiobarbituric acid (TBA) assay
1. Mix 1 volume of Reagent A with 100 volumes of Reagent C to prepare working reagent.	1. Mix 0.1 mL sample, 0.4 mL H_2O_2 , and 0.2 mL 7% SDS.
2. Add 950 μL of working reagent to 50 μL of sample.	2. Stir gently and add 2 mL 0.1 N HCl.
3. Incubate at room temperature for 30 min.	3. Add 0.3 mL 10% phosphotungstic acid.
4. Read at 560 nm (or 595 nm for ELISA plate readers).	4. Incubate 5 min at room temperature.
	5. Add 1 mL 0.67% TBA and acetic acid.
	6. Heat 45 min at 95°C.
	7. Cool in ice bath.
	8. Add 5 mL butanol.
	9. Vortex and centrifuge for 15 min.
	10. Determine lipid peroxide concentration in butanol layer by fluorescence at 515 nm excitation and 553 nm emission.
Total time: 35 min	Total time: 80–90 min

Related references

- Coutant F et al. (2002) Mature dendritic cell generation promoted by lysophosphatidylcholine. *J Immunol* 169:1688–1695.
- Goyer A et al. (2002) Isolation and characterization of a thioredoxin-dependent peroxidase from *Chlamydomonas reinhardtii*. *Eur J Biochem* 269:272–282.
- Requena J et al. (2001) Glutamic and aminoadipic semialdehydes are the main carbonyl products of metal-catalyzed oxidation of proteins. *Proc Natl Acad Sci USA* 98:69–74.

Fluorescence-based protein detection

While colorimetric assays are the most common method of total protein quantitation, there are times when other approaches may be warranted. In cases where sensitivity or limited sample size might be an issue, fluorescence-based protein quantification detection methods may be a better option for total protein quantitation. These assays are also compatible with high-throughput formats.



Fluorescence-based total protein assays



Fluorescence-based protein quantitation is an alternative to absorption-based colorimetric methods. Fluorescence detection methods provide excellent sensitivity, requiring less of your protein sample for quantitation and leaving more sample available for your experiment. We offer several fluorescence-based protein assays that require few steps (Table 15). Additionally, timing is not a critical factor, so the assays can be adapted for automated handling in high-throughput applications. The fluorescence signal can be detected using a fluorometer (e.g., Invitrogen™ Qubit™ 3 Fluorometer) or microplate reader.

Table 15. Technical summary of Invitrogen fluorescent protein assays.

Product	Invitrogen™ Quant-iT™ Protein Assay Kit	Invitrogen™ Qubit™ Protein Assay Kit	Invitrogen™ NanoOrange™ Protein Quantitation Kit	Invitrogen™ CBQCA Protein Quantitation Kit	Invitrogen™ EZQ™ Protein Quantitation Kit
Cat. No.	Q33210	Q33211/Q33212	N6666	C6667	R33200
Applications	Best for more than 20 samples	Best for 1–20 samples Compatible with Qubit 3 Fluorometer	Ideal for quantitating protein samples before gel electrophoresis and western blot analysis	Better suited for accurate quantitation of proteins in the presence of lipids, membrane fractions, or detergents, and for lipoproteins and small peptides	Ideal for determining protein concentration prior to electrophoresis Solid-phase format designed for high-throughput analysis
Detection wavelength (nm)	470/570	470/570	470/570	450/550	280 and 450/618
Sensitivity and effective range	Quasi-linear from 0.5 to 4 µg in a 200 µL assay volume, with a sample volume of 1–20 µL	Quasi-linear from 0.5 to 4 µg in a 200 µL assay volume, with a sample volume of 1–20 µL	10 ng/mL to 10 µg/mL	10 ng/mL to 150 µg/mL	50 µg/mL to 5 mg/mL, with a sample volume of 1 µL
Mechanism of action	Binds to detergent coating on proteins and hydrophobic regions of proteins; the unbound dye is nonfluorescent	Binds to detergent coating on proteins and hydrophobic regions of proteins; the unbound dye is nonfluorescent	Binds to detergent coating on proteins and hydrophobic regions of proteins; the unbound dye is nonfluorescent	Reacts with primary amine groups on proteins in the presence of cyanide or thiols; the unreacted dye is nonfluorescent	Binds electrostatically to basic amino acids, supplemented by additional hydrophobic interactions
High sensitivity	✓	✓	✓	✓	
Little protein-to-protein variation	✓	✓	✓		✓
Signal duration	3 hr	3 hr	6 hr	5 hr	–

Amine detection

o-Phthalaldehyde fluorescent protein assay

o-Phthalaldehyde (OPA) reacts with primary amines of amino acids, peptides, and proteins to enable fluorescence detection and quantitation. When reacted with primary amines in the presence of 2-mercaptoethanol, OPA yields an intensely blue-colored fluorescent product that has maximum excitation and emission wavelengths of 340 nm and 455 nm, respectively [1,2] (Figure 38). Wavelengths of 330–375 nm have been used for excitation and 436–490 nm for measuring emission. Protein concentrations as low as 50 ng/mL can be measured with an OPA assay. The inherent sensitivity and speed of OPA, along with its broad linear range, make it a useful protein and peptide assay reagent or as a pre- or post-column detection reagent for amino acid analysis (e.g., HPLC). OPA is ideal for assaying peptides that do not contain tyrosine residues, or for other applications in which absorbance at 280 nm cannot be used. Proteins and peptides tested yield linear results over a wide range of concentrations using both standard and microassay protocols.

There is considerable protein-to-protein and peptide-to-peptide variation with the OPA assay, making it best to use a purified sample of the particular protein or peptide as the standard. When this is not possible, the next best option is to use a protein or peptide that gives a response similar to the sample. Alternatively, a commonly accepted standard protein such as BSA can be used.

Reducing agents and metal chelators do not interfere with an OPA-based assay, provided they are included in the blanks and standards. In addition, most detergents do not interfere. Any common sample buffers and constituents are also compatible, but buffers with primary amines such as Tris or glycine buffers will interfere with OPA and must be avoided. Acetylated and other primary amine-blocked peptides will not give a response with OPA. OPA is commercially available in both liquid and crystal formats.

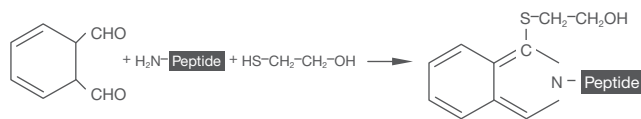
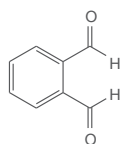

Figure 38. The reaction of *o*-phthalaldehyde with a primary amine on a peptide in the presence of 2-mercaptoethanol to form a fluorescently labeled peptide.

References

1. Ogden G, Foldi P (1987) Amino acid analysis: An overview of current methods. *LC-GC* 5(1):28–38.
2. Roth M (1971) Fluorescence reaction for amino acids. *Anal Chem* 43:880–882.

Fluoraldehyde *o*-phthalaldehyde reagents



Fluoraldehyde
o-phthalaldehyde
MW 134.13
 $\lambda_{\text{ex}} = 340 \text{ nm}$
 $\lambda_{\text{em}} = 455 \text{ nm}$

Figure 39. Fluoraldehyde *o*-phthalaldehyde.

Thermo Scientific™ Fluoraldehyde *o*-Phthalaldehyde Reagent Solution contains a stabilized, highly purified preparation of *o*-phthalaldehyde, Brij-35 detergent, and 2-mercaptoethanol in a specially formulated borate buffer. It is a highly sensitive, ready-to-use reagent solution that exhibits excellent linear response (Figure 40) and offers outstanding shelf life (Figure 41). In addition, when compared to other *o*-phthalaldehyde detection reagents, our solution exhibits decreased background over time and a high signal-to-noise ratio.

Thermo Scientific™ Fluoraldehyde™ *o*-Phthalaldehyde Crystals are a specially purified, fluorogenic-grade preparation of OPA. This amine-reactive compound is primarily used for high-sensitivity, fluorescence detection of primary amines, including amino acids, peptides, proteins, and polyamines in pre- or post-column chromatographic effluents. Simply dissolve the crystals in an appropriate buffer to perform the OPA assay with protein samples.

Highlights:

- **Accurate**—broad linear assay range for concentration measurement with standard curve
- **Ready to use**—no reagent preprocessing needed
- **Versatile**—reacts with all primary amine-containing analytes
- **Compatible**—reducing agents, metal chelators, and most detergents do not interfere with assay
- **Specialized**—ideal for work with recombinant proteins, synthetic peptides, and HPLC analytes
- **Highly sensitive**—detection as low as 50 ng/mL with low background

Application note:

For even greater sensitivity, use a combination of OPA with Fmoc-chloride with automated pre-column derivatization, detecting both primary and secondary amines. With this application, primary amino acids are first derivatized with OPA, while unreacted secondary amino acids are then reacted with Fmoc-chloride, resulting in extraordinary amino acid detection sensitivity and accuracy [1].

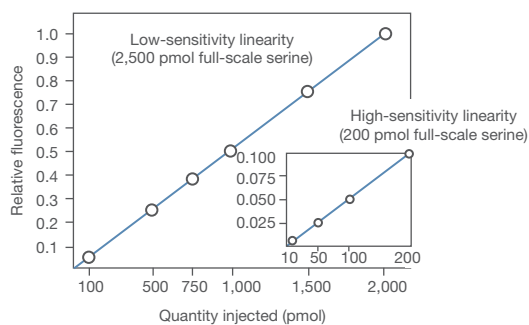

Figure 40. Excellent linear response. Fluoraldehyde reagent solution shows excellent linear response, whether in the 0–200 or 0–2,500 pmol range.

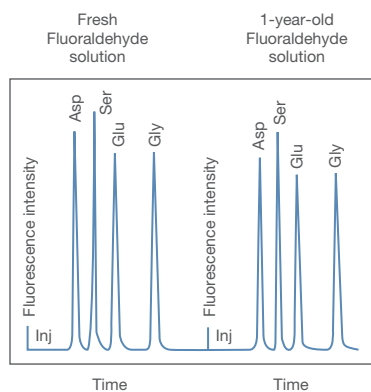

Figure 41. Outstanding shelf life. Comparison of fluorescence response of selected amino acids after reaction with recently prepared and 1-year-old Fluoraldehyde reagent solutions.

Reference

1. Lee KS, Drescher DG (1979) Derivatization of cysteine and cystine for fluorescence amino acid analysis with the *o*-phthalaldehyde/2-mercaptoethanol reagent. *J Biol Chem* 254:6248–6251.

Spectrophotometers and fluorometers

Once the total protein assay is complete, results are read using either a UV-Vis spectrophotometer for colorimetric-based assays or a fluorometer for fluorescence-based assays. The choice of which instrument to use depends on the device's sensitivity, throughput, absorbance, and fluorescence capabilities, and whether or not it can accommodate a microplate.



NanoDrop One/One^c Microvolume UV-Vis Spectrophotometers



The next-generation Thermo Scientific™ NanoDrop™ One Microvolume UV-Vis Spectrophotometers feature the innovative Thermo Scientific™ Acclaro Sample Intelligence technology designed to give you more knowledge about sample quality before use. With only 1–2 μL of DNA, RNA, or protein, you can obtain accurate sample concentrations with full-spectral data (190–850 nm) in seconds, and identify contaminants that may affect your downstream applications. Save days of rework from poor sample quality when you obtain corrected concentrations and use guided technical support to reliably assess sample purity.

The ergonomic, stand-alone design of the NanoDrop One Spectrophotometer includes a touch-screen interface with a cuvette option for expanded flexibility and dynamic range beyond the pedestal measurement. The instrument's intuitive software contains preconfigured methods for a wide array of nucleic acid and protein analysis, including methods for the Pierce 660 nm, Bradford, BCA, and Lowry protein assays. The software also allows for custom methods development and provides data export capabilities (e.g., Wi-Fi, USB, or ethernet).

For more details, visit
thermofisher.com/nanodrop

NanoDrop 8000 UV-Vis Spectrophotometer



Thermo Scientific™ NanoDrop™ 8000 Microvolume UV-Vis Spectrophotometer offers higher-throughput, full-spectrum absorbance measurements (220–750 nm), allowing you to quantify more samples in less time with full-spectral data and renowned NanoDrop reliability. The NanoDrop 8000 instrument can analyze up to eight samples simultaneously and quantify 96 samples in less than 6 minutes. The system accommodates sample volumes as small as 1–2 μL , with no dilutions required, making it ideal for monoclonal antibody quantitation from cell culture solutions.

The instrument's intuitive software contains preconfigured methods for a wide array of nucleic acid and protein analyses, including methods for the Pierce 660 nm, Bradford, BCA, and Lowry protein assays. The software also allows for custom method development and uses a PC or laptop computer for operation.

Related products

Thermo Scientific™ NanoDrop™ 2000 and 2000c instruments are full-spectrum, UV-Vis spectrophotometers to quantify and assess the purity of DNA, RNA, protein, and more. The Thermo Scientific™ NanoDrop™ Lite Spectrophotometer is a compact, personal UV-Vis microvolume spectrophotometer that is ideal for routine nucleic acid and protein measurements.

Multiskan GO Microplate Spectrophotometer



The Thermo Scientific™ Multiskan™ GO Microplate Spectrophotometer provides both microplate- and cuvette-based measurements of samples using selectable wavelengths from 200 to 1,000 nm. The Multiskan GO Spectrophotometer features path length correction and an incubation option up to 45°C. The instrument provides fast plate measurements and a full sample spectrum in less than 10 seconds. Its intuitive user interface lets you run quick measurements directly from the instrument—or use the comprehensive and easy-to-use Thermo Scientific™ Skant™ Software for more demanding assays.

For more details, visit
thermofisher.com/platereaders

Qubit 3 Fluorometer



The Invitrogen™ Qubit™ 3.0 Fluorometer is the next generation of the popular benchtop fluorometer that accurately measures DNA, RNA, and protein using the highly sensitive Qubit quantitation assays. The concentration of the target molecule in the sample is reported by a fluorescent dye that emits a signal only when bound to the target, which minimizes the effects of contaminants—including degraded DNA or RNA—on the result. The easy-to-use touch-screen menus make it easy to select and run the assays you need, with results displayed in just a few seconds.

For more details, visit
thermofisher.com/qubit

Ordering information

Product	Quantity	Cat. No.
Standards for total protein assays		
Pierce Bovine Serum Albumin Standard, Pre-Diluted Set	7 x 3.5 mL	23208
Pierce Albumin Standard Ampules, 2 mg/mL	10 x 1 mL	23209
Pierce Albumin Standard, 2 mg/mL	50 mL	23210
Pierce Bovine Gamma Globulin Standard Ampules, 2 mg/mL	10 x 1 mL	23212
Pierce Bovine Gamma Globulin Standard, Pre-Diluted Set	7 x 3.5 mL	23213
Mouse Gamma Globulin Isotype Control	10 mg	31878
Rabbit Gamma Globulin Isotype Control	10 mg	31887
Rat Gamma Globulin Isotype Control	10 mg	31885
Goat Gamma Globulin Isotype Control	10 mg	31871
Human Gamma Globulin Isotype Control	10 mg	31879
BCA-based protein assays		
Pierce Rapid Gold BCA Protein Assay Kit	250 mL	A53226
Pierce Rapid Gold BCA Protein Assay Kit	500 mL	A53225
Pierce BCA Gold BCA Protein Assay Kit	20 mL	A53227
Pierce BCA Protein Assay Kit – Reducing Agent Compatible	275 mL	23250
Pierce Microplate BCA Protein Assay Kit – Reducing Agent Compatible	275 mL	23252
Pierce BCA Protein Assay Kit	1 L	23225
Pierce BCA Protein Assay Kit	500 mL	23227
Pierce BCA Protein Assay Reagent A	250 mL	23221
Pierce BCA Protein Assay Reagent A	1 L	23223
Pierce BCA Protein Assay Reagent A	3.75 L	23222
Pierce BCA Protein Assay Reagent B	25 mL	23224
Pierce BCA Solid	25 g	23230
Pierce BCA Protein Assay Reagent A	500 mL	23228
Micro BCA Protein Assay Kit	500 mL	23235
Micro BCA Reagent A (MA)	240 mL	23231
Micro BCA Reagent B (MB)	240 mL	23232
Micro BCA Reagent C (MC)	12 mL	23234
Compat-Able BCA Protein Assay Kit	1 L	23229
Compat-Able Protein Assay Preparation Reagent Kit	500 mL	23215
Dye-based protein assays		
Pierce Detergent Compatible Bradford Assay Kit	300 test tube assays	23246
Pierce Coomassie Plus (Bradford) Assay Kit	950 mL	23236
Pierce Coomassie Plus (Bradford) Reagent	300 mL	23238
Compat-Able Coomassie Plus Protein Assay Kit	1.5 L	23239
Compat-Able Protein Assay Preparation Reagent Set	500 mL	23215
Pierce Coomassie (Bradford) Protein Assay Kit	950 mL	23200
Pierce 660 nm Protein Assay Reagent	750 mL	22660
Pierce 660 nm Protein Assay Kit	45 mL	22662
Ionic Detergent Compatibility Reagent (for Pierce 660 nm Protein Assay Reagent)	5 x 1 g	22663
Modified Lowry protein assay		
Pierce Modified Lowry Protein Assay Kit	530 mL	23240

Product	Quantity	Cat. No.
Specialty assays		
Pierce Quantitative Colorimetric Peptide Assay	500 assays	23275
Pierce Quantitative Fluorometric Peptide Assay	500 assays	23290
Peptide Digest Assay Standard	1.5 mL	23295
Easy-Titer Human IgG (H+L) Assay Kit	96 tests	23310
Easy-Titer Human IgM Assay Kit	96 tests	23315
Easy-Titer Mouse IgG Assay Kit	96 tests	23300
Easy-Titer Rabbit IgG Assay Kit	96 tests	23305
Easy-Titer Human (gamma chain) IgG Assay Kit	96 tests	23325
Human IgG, Whole Molecule Control	10 mg	31154
Human IgM (yeloma), Whole Molecule Control	2 mg	31146
Rabbit IgG, Whole Molecule Control	10 mg	31235
Pierce 96-Well Plates, Corner Notch	100 plates	15041
Pierce 8-Well Strip Plates, Corner Notch	100 plates	15031
Pierce Colorimetric Protease Assay Kit	250 tests	23263
Pierce Fluorescent Protease Assay Kit	1,000 tests	23266
FITC-Casein for Pierce Fluorescent Protease Assay Kit	2.5 mg	23267
Pierce Glycoprotein Carbohydrate Estimation Kit	500 mg	23260
Glycoprotein Standards Set for Pierce Glycoprotein Carbohydrate Estimation Kit	5 proteins	23259
Pierce Phosphoprotein Phosphate Estimation Assay Kit	100 mL	23270
Pierce Quantitative Peroxide Assay Kit (Aqueous)	100 mL	23280
Pierce Quantitative Peroxide Assay Kit (Lipid)	100 mL	23285
Fluorescent protein assays		
Qubit Protein Assay Kit	100 assays	Q33211
Qubit Protein Assay Kit	500 assays	Q33212
Quant-iT Protein Assay Kit	1 kit	Q33210
EZQ Protein Quantitation Kit	2,000 assays	R33200
CBQCA Protein Quantitation Kit	1 kit	C6667
NanoOrange Protein Quantitation Kit	1 kit	N6666
Amine detection assays		
Fluoraldehyde o-Phthalaldehyde Crystals (OPA)	5 g	26015
Fluoraldehyde o-Phthalaldehyde Reagent Solution	945 mL	26025
Spectrophotometers and fluorometers		
NanoDrop One Microvolume UV-Vis Spectrophotometer with Wi-Fi	1 instrument	ND-ONE-W
NanoDrop One° Microvolume UV-Vis Spectrophotometer with Wi-Fi	1 instrument	ND-ONEC-W
NanoDrop 8000 Microvolume UV-Vis Spectrophotometer	1 instrument	ND-8000-GL
NanoDrop 2000 Microvolume Spectrophotometer	1 instrument	ND-2000
NanoDrop 2000° Microvolume Spectrophotometer (with cuvette capability)	1 instrument	ND-2000C
NanoDrop Lite UV-Vis Spectrophotometer	1 instrument	ND-LITE
Qubit 3.0 Fluorometer	1 instrument	Q33216
Qubit Assay Tubes	500 tubes	Q32856

More protein assay applications resources online

Interactive protein assay selection guide



No one reagent or product can be considered to be the ideal or best protein assay method. Each method has its advantages and disadvantages. Our new interactive protein assay selection tool can help you to select

the best protein assay for your application based on the sample composition and your preferred method.

Find the right product at
thermofisher.com/protein-assay-tool

Technical tips—short articles for protein assay applications

Our technical tips provide a more in-depth understanding on addressing the common challenges around optimizing protein assay determinations for improved downstream results. Protein assay topics include:

Tech Tip #6: Extinction coefficients. This article provides a guide to understanding extinction coefficients, with emphasis on spectrophotometric determination of protein concentration.

Tech Tip #8: Eliminate interfering substances from samples for BCA protein assays. This article describes various methods to remove substances that interfere with accurate protein quantitation using the BCA assay.

Tech Tip #9: Quantitate immobilized protein. This article highlights the use of the Bradford protein assay to estimate the amount of protein immobilized on a support.

Tech Tip #25: Determine acceptable wavelengths for measuring protein assays. This article provides a simple guide for determining which wavelengths are likely to be successful for measuring protein assay results. The general response patterns observed in these data are representative of most variants of BCA and Coomassie (Bradford) protein assay methods.

Tech Tip #57: How to use a protein assay standard curve. This article describes how to properly calculate sample protein concentrations using a standard curve. Pierce protein assays are used as examples, but the principles apply to protein assay methods in general.

Tech Tip #75: Measure protein bound to Thermo Scientific™ Pierce™ NHS-activated magnetic beads. This article describes how to directly measure protein coupled to NHS-activated magnetic beads using a BCA protein assay method.

Download these technical tips at
thermofisher.com/proteinassays

Find out more at thermofisher.com/proteinassays

ThermoFisher
S C I E N T I F I C

For Research Use Only. Not for use in diagnostic procedures. © 2017 Thermo Fisher Scientific Inc. All rights reserved. All trademarks are the property of Thermo Fisher Scientific and its subsidiaries unless otherwise specified. Triton is a trademark of Dow Chemical Co. Brij and Span are trademarks of Uniqema Americas. Tween is a trademark of Croda Americas. Bio-Rad, DC, and Quick Start are trademarks of Bio-Rad Laboratories. Zwittergent is a trademark of Merck KGAA. **COL04277 0717**